

OVERSEAS ROAD NOTE **7**
Vol 2

Bridge
Inspector's
Handbook

TRL Limited
Crowthorne, Berkshire, United Kingdom

Guidance on the use of this handbook is given in the complementary publication:

Overseas Road Note 7, (Volume 1)

A Guide to Bridge Inspection and Data Systems for District Engineers.

First edition published by the Transport and Road Research Laboratory, 1988

Reprinted with minor amendments by TRL Limited, 2004

Copyright © 1988, 2004

Limited extracts from the text may be reproduced, provided the source is acknowledged.

For more extensive reproduction please write to:

The Director, TRL Limited.

OVERSEAS ROAD NOTES

Overseas Road Notes are prepared principally for road and transport authorities in countries receiving technical assistance from the British Government. A limited number of copies are available to other organisations and to individuals with an interest in roads overseas.

Enquiries should be made to:

TRL Limited
Old Wokingham Road
Crowthorne
Berkshire
RG45 6AU
England

ACKNOWLEDGEMENTS

This handbook was drafted by Mr J D Parry of the Overseas Unit, TRRL (now TRL Limited). It is based on an original text by Rendel, Palmer and Tritton, Consulting Engineers and is published by permission of the Director, Transport and Road Research Laboratory (now TRL Limited).

FOREWORD

In many developing countries there is a shortage of trained bridge engineers. Where this is so, other personnel must be used for routine bridge inspections, or the bridges are neglected and deteriorate. Using this handbook, a person with experience, but little formal technical training, such as a road maintenance supervisor, should be able to carry out routine bridge inspections on the majority of bridges.

This handbook utilises an inspector's report form, which also provides a check list of items to be inspected. For each item, detailed but simple, advice is given on what to look for.

Large or unusual bridges, such as suspension bridges, are beyond the scope of this handbook, and should therefore be inspected by an engineer.

Both technical content and language have been simplified to make this handbook usable by people whose knowledge of engineering, and/or English, is not highly developed.

It must be stressed that this handbook aims only to support and guide a suitable person in how to inspect a bridge on behalf of the engineer. The final responsibility must lie with the engineer.

CONTENTS

PART (1) – ABOUT BRIDGES

	<i>Page No</i>
To the bridge inspector	[1] – 1
Introduction	[1] – 5
TYPES AND PARTS OF BRIDGES	[1] – 6
General	[1] – 6
Superstructure	[1] – 7
Abutments, wing walls and retaining walls	[1] – 13
Piers	[1] – 18
MOVEMENT	[1] – 20
General	[1] – 20
Bearings and joints	[1] – 21
DAMAGE AND PROTECTION AGAINST DAMAGE	[1] – 26
Impact damage	[1] – 26
River damage	[1] – 28
Protection against scour	[1] – 33
Slope protection	[1] – 33
Bed protection	[1] – 36
River training works	[1] – 37
Other natural causes of damage	[1] – 38
Water	[1] – 38
Debris, dirt and vegetation	[1] – 40
Earthquakes	[1] – 42
Landslides	[1] – 42
BRIDGE MATERIALS	[1] – 43
Concrete	[1] – 43
Steel	[1] – 56
Masonry	[1] – 67
Timber	[1] – 72
Gabions	[1] – 80
CULVERTS	[1] – 83

PART (2) – THE INSPECTION

	<i>Page No</i>
Introduction	[2] – 1
The report form: Page 1	[2] – 3
The report form: Page 2	[2] – 6
The report form: Page 3 onwards	[2] – 8
Road approaches and deck	[2] – 15
Bridge surface and footpaths	[2] – 18
Parapets, railings and guard rails	[2] – 27
Expansion joints	[2] – 32
The river	[2] – 34
Superstructure	[2] – 41
Main beams, girders, trusses and bracings	[2] – 44
Underside of deck	[2] – 59
Bearings	[2] – 64
Masonry arches	[2] – 70
Bailey bridges	[2] – 75
Abutments, wing walls and retaining walls	[2] – 82
Embankments and fill in front of abutments	[2] – 96
Bed protection	[2] – 105
Piers	[2] – 110
Culverts	[2] – 119

APPENDICES

A WORD LIST	A – 1
B INSPECTION EQUIPMENT LIST	B – 1
C SAFETY DURING INSPECTIONS	C – 1
D EXAMPLE OF A COMPLETED REPORT FORM	D – 1

TO THE BRIDGE INSPECTOR

Often, a bridge inspector is a qualified engineer. But sometimes, there are not enough engineers to do this work, and other people become bridge inspectors.

Inspecting a bridge is a very responsible job. It is not an easy job, and there are many things to learn before you can inspect a bridge properly. This handbook explains the things you need to know to inspect a bridge.

BEFORE YOU INSPECT A BRIDGE, YOU MUST READ PART [1] OF THIS HANDBOOK AND UNDERSTAND EVERYTHING IN IT.

Part [1] of this handbook tells you the names of different parts of bridges. It explains the different kinds of bridges and tells you how bridges can be damaged. It also gives you basic information about concrete, steel, masonry and timber, as they are used in bridges.

Part [2] of this handbook helps you to inspect a bridge and fill in an inspection report form. You must read Part [1], so that you will understand the engineering terms used in Part [2]. Before you inspect a bridge, you should read Part [2]. When you go to inspect a bridge, take this book with you, as it will tell you what things must be checked and how to fill in the inspection report form.

If you have some experience of bridges, the information in the book will not be difficult for you.

If you speak English in your job, you will already know many of the engineering words which are used. If not, you will need to learn some new words. To help you there is a word list in Appendix A.

Appendix A is at the back of this handbook on pages A - 1 to A - 8. It is a list of the engineering words and their meanings. The first time each of these words is used in the handbook, it is printed in CAPITALS, so you will know you can find it in the word list.

A small handbook like this one cannot teach you everything about bridges. Sometimes you must ask an engineer to explain things to you. The engineer you are working for should be willing to help you with any problems.

Appendix B is a list of equipment you will need when you are inspecting bridges. You may think of other useful things to add to this list. You should keep all these things in good condition and check them after each inspection, so that you will have a full set of tools and equipment when you arrive at the next bridge.

Appendix C is about safety and is very important. Please read this carefully.

Appendix D is an example of a completed inspection report form. When you inspect a bridge, your report form will have ticks in different places. The number in the first column, on the left side of the page, tells you which page to look at in Part [2] of this book, if you need help with that part of the inspection.

This handbook does not tell you about suspension bridges, cable-stayed bridges or movable bridges, and it does not tell you about very large bridges. These bridges must be inspected by a bridge engineer.

A bridge inspector must know many things and he must also have many good qualities.

There are 3 qualities which are very important:

1. A bridge inspector must be a careful worker. You must always look at a bridge carefully and fill in the inspection report form carefully. It is better to be slow and careful.
2. A bridge inspector must be a safe worker. You must be in good health and fit, so you can climb over parts of a bridge safely. Safety is very important and you must never take unnecessary risks.
3. A bridge inspector must be a responsible person. A good inspector can help prevent road accidents and keep the roads open to traffic.

PART (1) – ABOUT BRIDGES

INTRODUCTION

Bridges can be the weak links in a road network. They must be very well maintained in order to keep the roads open to traffic. Most of the bridges you will inspect carry a road over a river. Culverts are included too, because they are like small bridges and if a culvert collapses the road may have to be closed.

As an inspector you will be looking for damage which has already happened, or will soon happen. You will be looking at the bridge, the material it is made from, and also the river. The river is important because it can damage the bridge.

To understand about damage to bridges, you must understand something about the materials used in bridges. The materials most commonly used for bridge construction are concrete, steel, masonry and timber. You will find notes on these materials at the end of Part [1].

TYPES AND PARTS OF BRIDGES

GENERAL

The simplest bridge is a single SPAN. Look at this picture of a single span bridge over a river. Study it carefully and learn any new words:

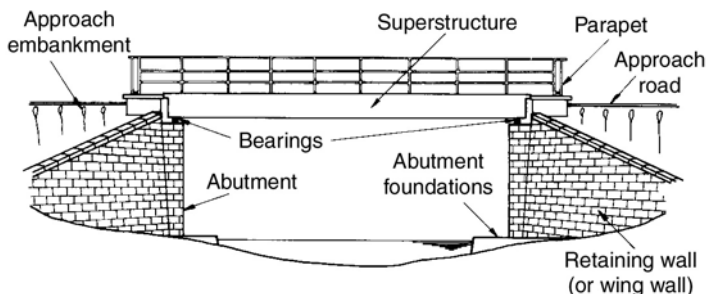

SINGLE SPAN BRIDGE

We call the part of the bridge which carries the road over the river the **SUPERSTRUCTURE**.

The superstructure sits on the **ABUTMENTS**.

The **BEARINGS** are between the superstructure and the abutments. Along both edges of the superstructure there is a **PARAPET**. The parapet stops people and light vehicles from falling off the bridge.

As well as supporting the superstructure, the abutments also retain (hold back) the **APPROACH EMBANKMENTS**. The **RETAINING WALLS** next to the abutments also retain the approach embankments. The **APPROACH ROAD** runs along the top of the approach embankment on to the bridge.

SUPERSTRUCTURE

If we could cut through the superstructure it may look like this:

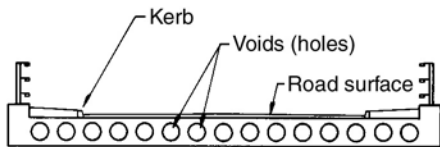

Concrete slab (voided)

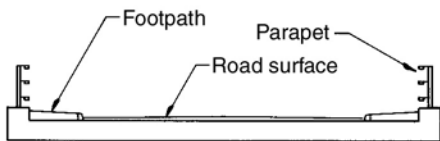

Concrete slab (solid)

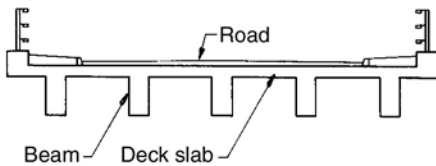

Concrete beam and slab

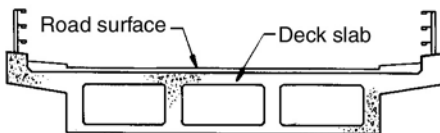

Concrete box girder

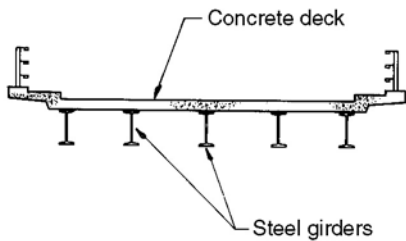

Steel girders with concrete deck

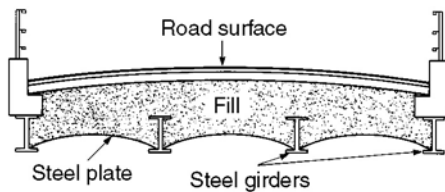

Steel girders with jack arch deck

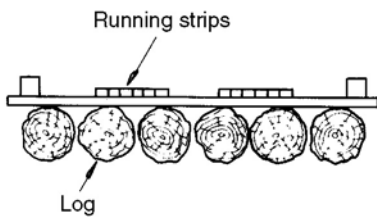

Log bridge

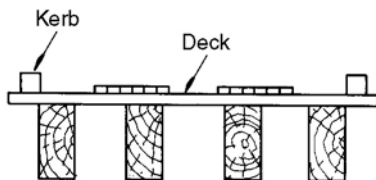

Timber beam

If a bridge is long, the superstructure needs to have more than a support at each end. These extra supports are called PIERS. In this book abutments and piers are called SUBSTRUCTURES.

This picture shows a 3-span bridge over a river:

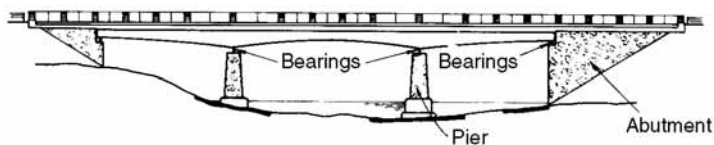

3 SPAN BRIDGE CONTINUOUS CONSTRUCTION

In the drawing above, the superstructure is one continuous piece. Only one set of bearings is needed at each pier.

The superstructure of a multi-span bridge (that is a bridge with 2, 3, or more spans) may be constructed of separate sections as shown below:

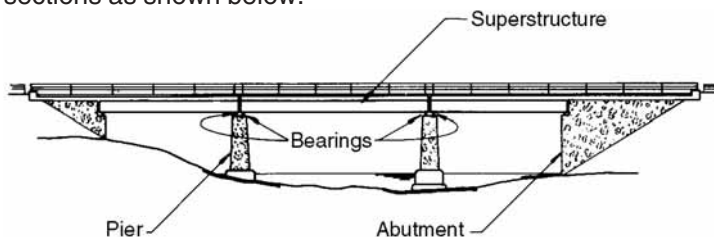

MULTI-SPAN SIMPLY SUPPORTED BRIDGE

In this case, the superstructure needs 2 sets of bearings at each pier, to allow each section to expand and contract.

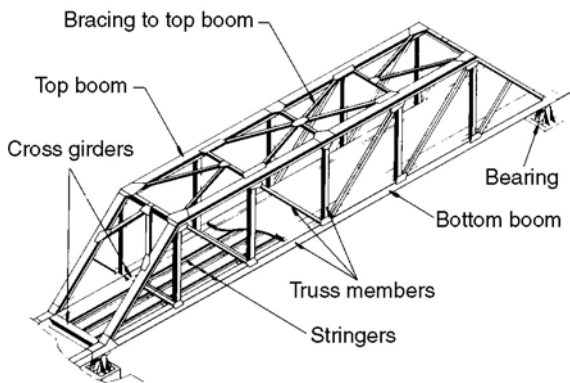

THROUGH TRUSS BRIDGE

The bridge shown above is called a TRUSS BRIDGE. The trusses are the 2 main GIRDERS which are made from a number of steel beams joined together. The joints are usually fixed with rivets or bolts. The trusses are connected by CROSS-GIRDERS and BRACING. The cross-girders and deck bracing connect the bottom BOOMS of the trusses, and bracing connects the top booms above the roadway. The road is supported on STRINGERS which span between the cross-girders.

This truss bridge is called a 'through truss' because the traffic goes through the bridge at the same level as the trusses.

The bridge in the picture below has no top bracing. It is a half-through truss bridge.



On some bridges the trusses are underneath the roadway. These bridges are called deck type truss bridges. One is shown on page [1] - 78.



MASONRY ARCH bridges are made from brick or stone masonry. The picture below shows a masonry arch and names the important parts of the bridge:

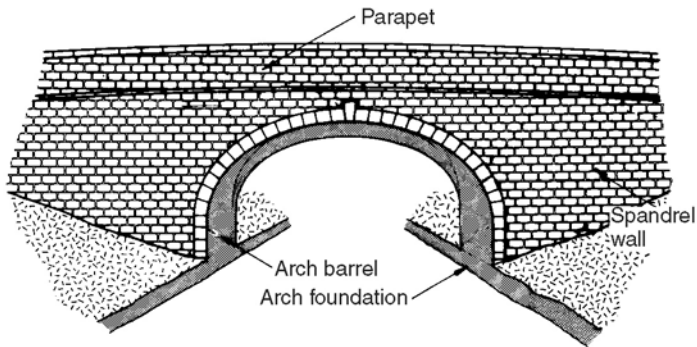

The arch BARREL is supported on FOUNDATIONS. The FILL which carries the roadway over the arch is contained by SPANDREL walls. The spandrel walls usually continue above the roadway as parapets.

ABUTMENTS, WING WALLS AND RETAINING WALLS

The weight of the superstructure and the abutments is carried by the abutment foundations. Abutments can have 3 types of foundations. They can have a SPREAD FOUNDATION directly on the soil or rock; they can have PILES; or they can have CAISSONS.

These pictures show the three types of foundations:

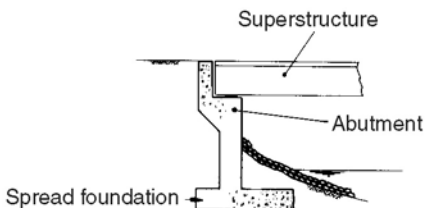

Abutment on spread foundation

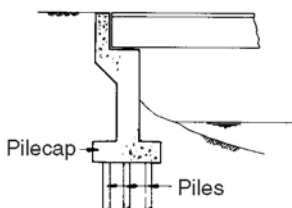

Abutment on piles

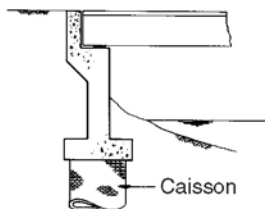

Abutment on caisson

Sometimes abutments sit high up on the river bank. These abutments are called BANK SEAT abutments. They may sit on piles as in the picture below, or on spread foundations as shown in the picture opposite.

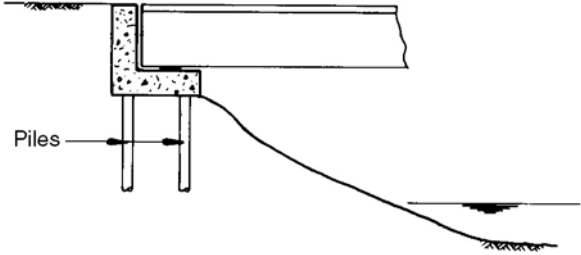

BANK SEAT ABUTMENT ON PILES

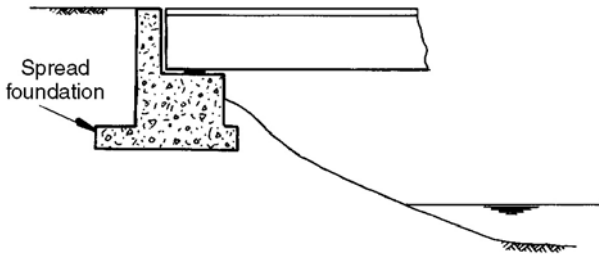

BANK SEAT ABUTMENT ON SPREAD FOUNDATION

Because their foundations are above river level, bank seat abutments can easily be damaged by the river SCOURING the bank beneath them, or by rain water running down the bank and ERODING the bank away. You will read more about this on pages [1] - 28 to [1] - 37.

The superstructure rests on bearings on the abutment
BEARING SHELF.

This picture shows a steel girder superstructure resting on an
abutment:

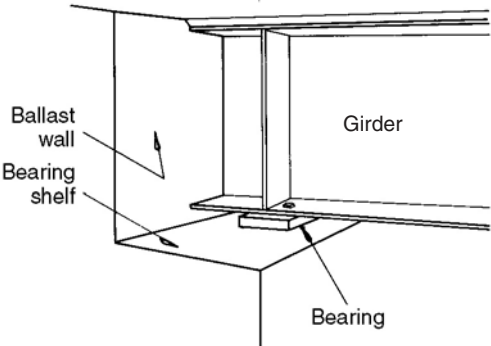

The part of the abutment which holds back the approach embankment above the bearing shelf is called the BALLAST WALL.

WING WALLS are attached to the abutment. They retain (hold in) the approach embankment.

This picture shows an abutment with wing walls.

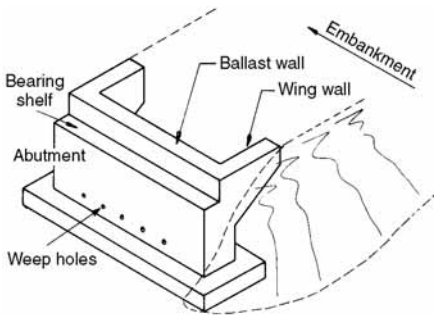

Sometimes retaining walls are used to hold back the embankment. They are separate from the abutment, and look like this:

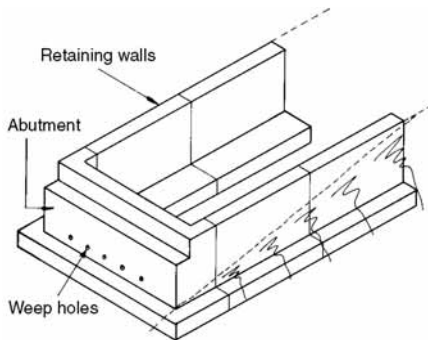

PIERS

Piers, like abutments, can rest on spread foundations, piles, or caissons:

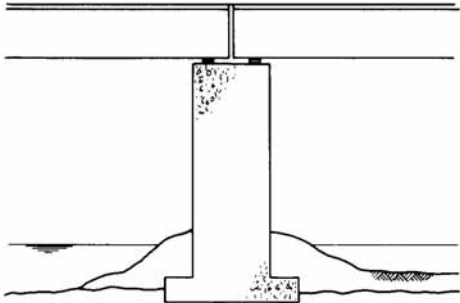

CONCRETE PIER ON SPREAD FOUNDATION

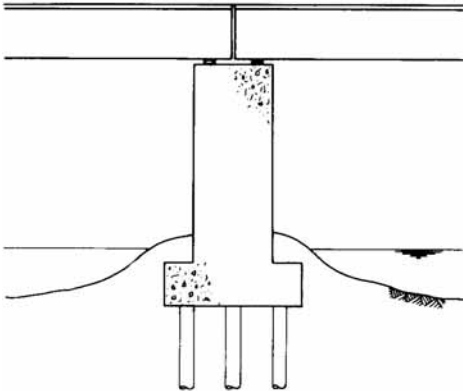

CONCRETE PIER ON PILES

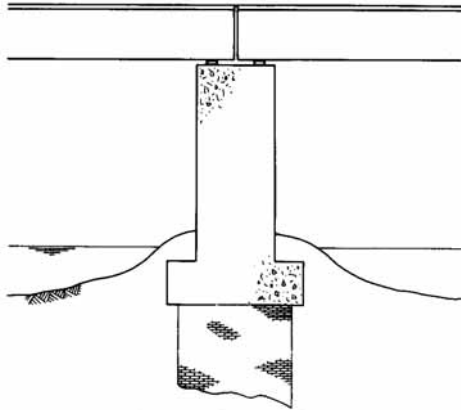

CONCRETE PIER ON CAISSON

On some bridges the piers are made by carrying piles or caissons from below ground up to the underside of the superstructure. The photograph on page [1] - 51 shows this.

On other bridges, such as the one in the photograph on page [2] - 110, concrete piers are supported on piles.

MOVEMENT

GENERAL

When the air temperature changes, the superstructure changes its length a little. It is usual that a bridge 50 metres long will change its length by about 25 mm (about 1 inch).

In areas with big temperature differences, such as deserts and mountain areas, the change in length (or expansion) will be bigger.

If the superstructure is fixed to both abutments, it will damage them when it changes length. On all big bridges the superstructure rests on bearings. The bearings carry the weight of the superstructure and allow it to move a little:

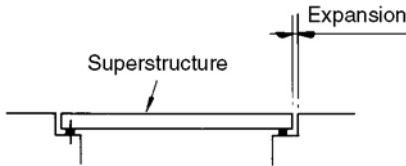

BEARINGS AND JOINTS

If the superstructure is free to move at both ends, the whole superstructure could fall off its bearings. To avoid this, usually one end of a span is fixed to the abutment or pier. The other end is free to move:

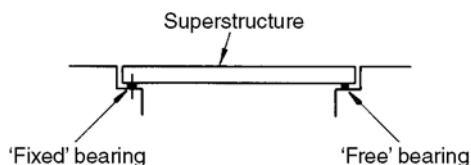

Fixed bearings usually have a pin or bolt fixing the beam to the support through the bearing. On concrete bridges it is not possible to see the pins used in the fixed bearings, so they cannot be checked. On steel girder bridges the heads of the bolts or pins can usually be inspected.

This is one type of fixed bearing, called a rocker bearing:

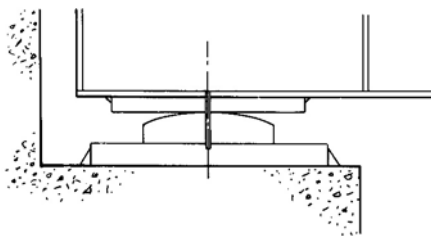

It is important that you know which bearings are fixed, and which are free. To find this out, look on the bridge record card before you go to the bridge.

There are many different types of free bearings, but movement is usually allowed in one of three ways:

- change of shape of rubber bearings;
- sliding between special surfaces;
- rolling on steel rollers.

Many modern bridges have rubber bearings. Some rubber bearings have steel PLATES inside. If you can see the steel inside the rubber, then the fault is bad:

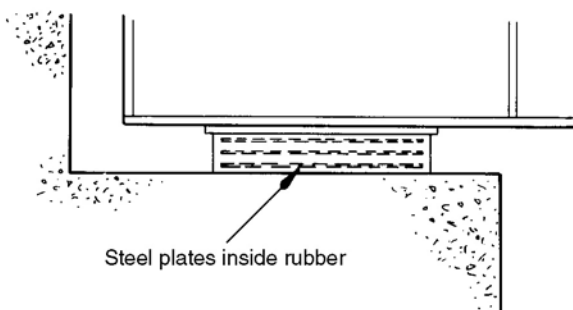

Metal bearings can be made of two plates, usually one steel plate and one bronze plate. Modern bridges may have a slippery material called PTFE between the sliding plates. This PTFE looks like wax and can be easily damaged because it is not very hard.

Some big bridges have roller bearings.

One type of roller bearing is shown here:

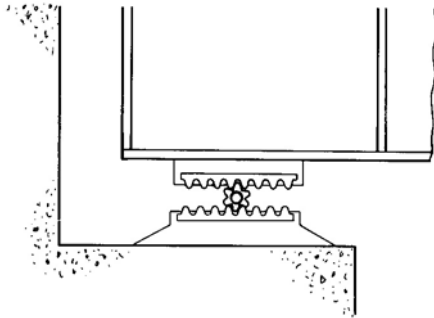

At the road surface. between the DECK and the ballast wall, there will be an expansion joint. There are many different types of expansion joints. The simplest joint is made by using steel angles in the end of the deck, and in the top of the abutment ballast wall.

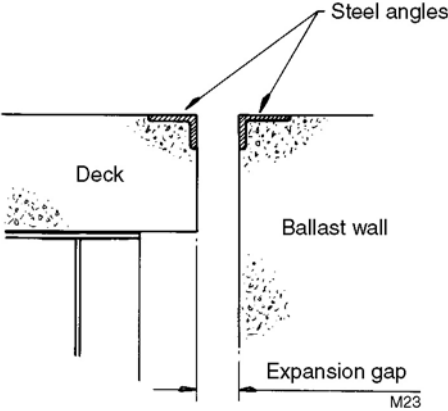

Sometimes a rubber WATER BAR is used to try to stop water and dirt from going through the expansion gap.

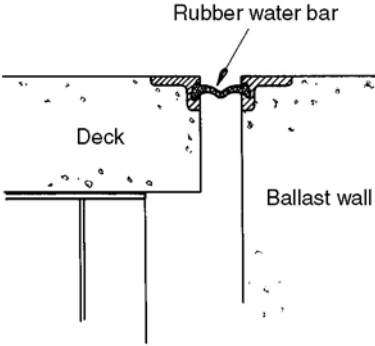

So far the bridge spans used as examples have been either simply supported (supported at two points only), or continuous (supported at more than two points). In each case the bearings and expansion joints are at the piers or abutments.

Another common form of construction is this:

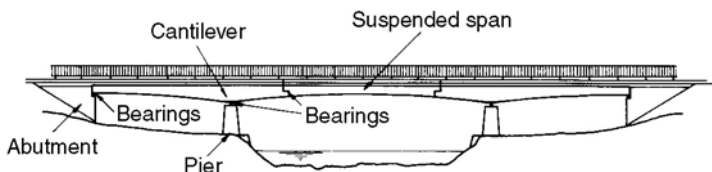

In this type of construction, there are bearings at the abutments and piers, and also there are bearings where the **SUSPENDED SPAN** sits on the **CANTILEVERS**. There are joints in the road at both abutments and at the ends of the suspended span.

Expansion joints in the bridge decks are often a problem, so you will have to look at them carefully during your inspections.

On some bridges (usually short span bridges) the bituminous surfacing is carried right over the joint so that you cannot see the joint itself. These are called buried joints.

When you are inspecting bridges with buried joints, because you cannot see the joint you must look for signs that the joint is not working. You are told how to do this in part [2] of this book.

DAMAGE AND PROTECTION AGAINST DAMAGE

Bridges are damaged by vehicles, by the river, or by other natural causes like CORROSION and rotting.



IMPACT DAMAGE

Vehicle impact causes a lot of damage to bridges. When a vehicle hits a parapet, the parapet will be damaged. If a heavy vehicle hits a parapet, then the main structure of the bridge may also be damaged. Through-truss and through-girder bridges can be seriously damaged by vehicle impact.

If a vehicle is too tall, it may damage the top bracing of a through-truss.

Sometimes a bridge carries a road over another road. If a vehicle leaves the road below, it may hit the bridge pier, or if the vehicle is too tall, it may hit the superstructure.

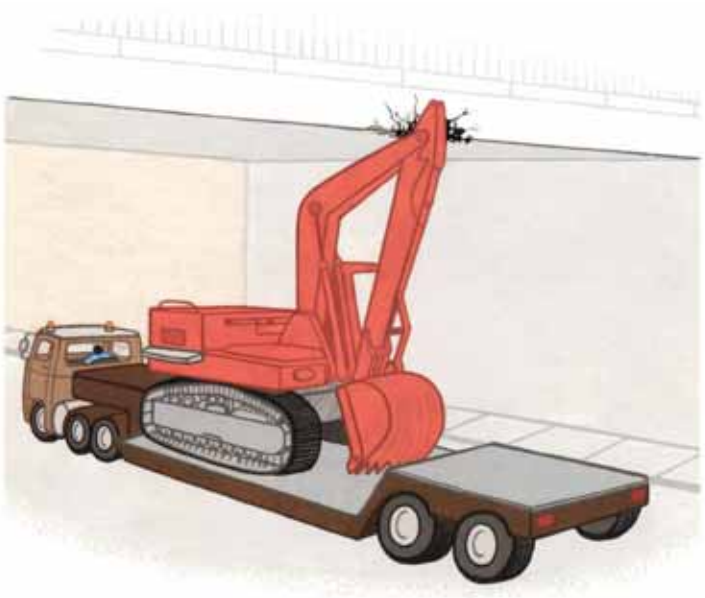

When the bridge is over a river, large logs or boats may hit the pier or the superstructure.

If an impact damages any part of the bridge, except the parapet, then an engineer must inspect the bridge. He will know how important the damage is.

RIVER DAMAGE

When a river flows very fast it picks up material from the river BED or banks and washes it away. This is called SCOUR. Sometimes scour causes large holes in river beds or washes large sections of the bank away. Many bridges have been destroyed by scour.

These 3 pictures show different types of damage caused by scour:

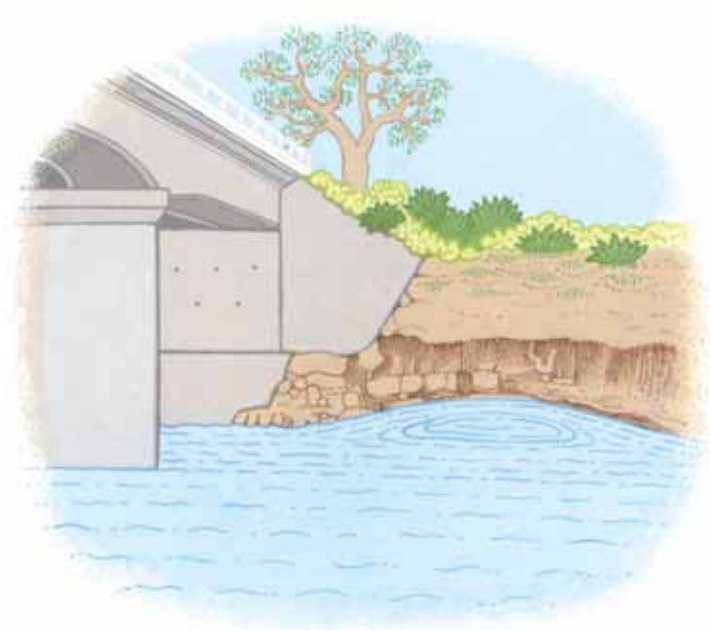

Scour of the river bank at the side of an abutment.

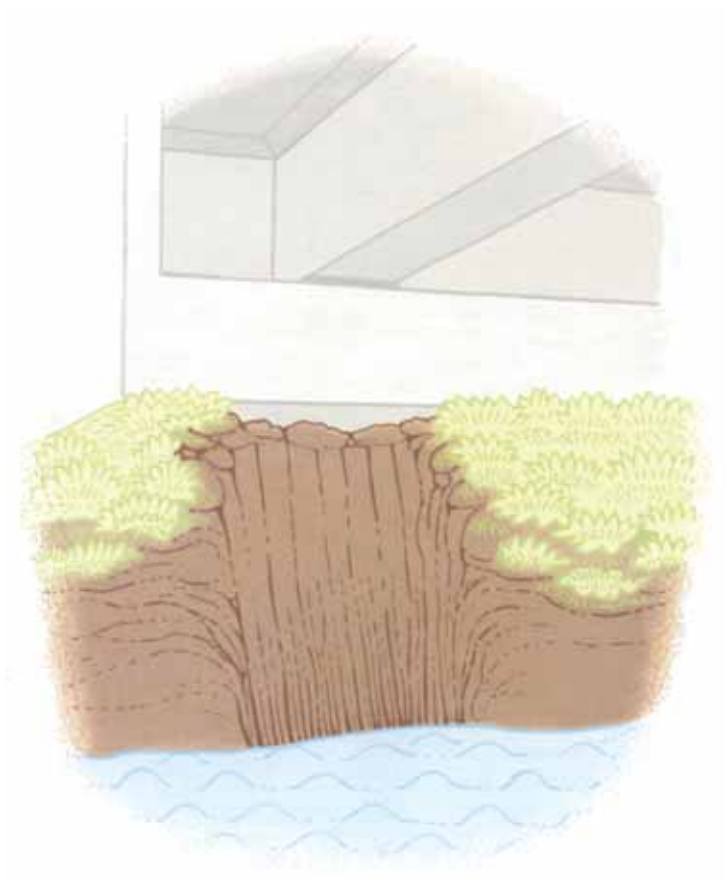

Scour of a river bank in front of a bankseat abutment.

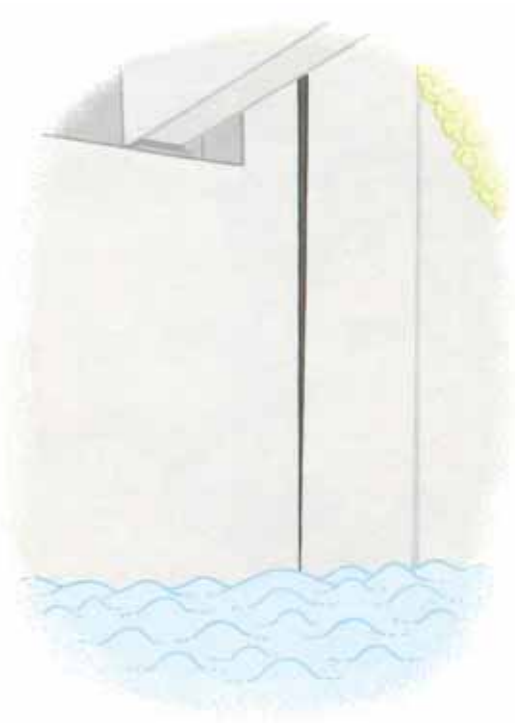

Scour causing a retaining wall to move forward.

Rivers can easily damage or destroy bridges. Usually bridges are damaged when the river is too big to go through the waterway under the bridge, or when the river changes its path.

There are 3 reasons why a river may not be able to go through the waterway of a bridge.

1. A river can grow and become too big for the waterway.
2. The waterway under the bridge can be blocked by parts of old bridges, trees, fences and other debris.
3. The waterway under the bridge was not made big enough.

If there is a flood which is too big for the waterway under the bridge, the river may do 3 things:

1. Wash away the bridge.
2. Wash away the road embankment and the road, and go round the bridge.
3. Wash away the fill in front of the abutments, and scour big holes in the river bed.

If the waterway is too small, another bridge or some culverts may be needed to carry the extra floodwater.

Rivers can change their path slowly or very quickly. Change of path can, after a time, cause damage to a bridge. For example, this picture shows how a new island can form around a large log and other debris:



A new island **UPSTREAM** of the bridge can make a river change its path and scour around an abutment, or under a pier.

To stop the river changing its path, training works are used.

These are described on page [1] - 37.

PROTECTION AGAINST SCOUR

If the river is causing scour, then the road embankment, the abutments and the piers can be protected with slope protection and bed protection.

Slope protection

There are 4 common ways to protect a slope:

- Piled walls.
- Stone pitching.
- Gabions.
- Rip-rap.

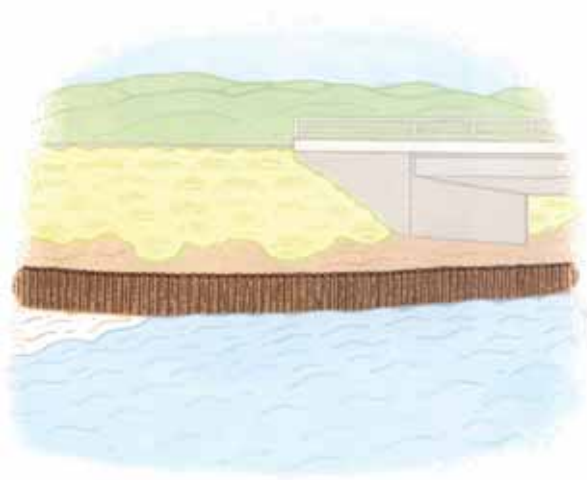

PILED WALLS are made from timber or steel. These timber or steel piles are hammered into the ground at the bottom of the slope. Sometimes the river scours in front of the piled walls, and the walls move forward. This is not serious if the walls are still protecting the slope.

STONE PITCHING is stones set in mortar on the slope. Stone pitching is a good way to protect a slope from water running down it. Stone pitching can be damaged by scour at the base of the embankment or by scour or erosion at the edge.

This photo shows the problem:



GABIONS (or RENO MATTRESSES) are wire baskets filled with stones. They are often used as slope protection. Because they can change shape and settle a lot without any damage, gabions are good for protecting slopes.

RIP-RAP is large rocks or blocks of concrete placed against the slope. For rip-rap to work, the rocks must be too heavy for the river to wash them away. Stones found in the river close to the bridge cannot be used as rip-rap. They will not be heavy enough. If the rip-rap is being washed away, it must be replaced with larger rocks.



This new rip-rap slope protection has been placed in a scour hole in front of a bank seat abutment.

Bed protection

Sometimes, to protect the bridge from scour, part or all of the bed of the river at the bridge is covered with stone pitching, concrete or gabions (or reno mattresses).

When all of the river bed under a bridge is covered by bed protection, the bed protection is called an INVERT.

For fast flowing rivers, it is sometimes necessary to carry this bed protection a long way DOWNSTREAM of the bridge or culvert.

Bed protection carried downstream of a bridge is called an APRON.

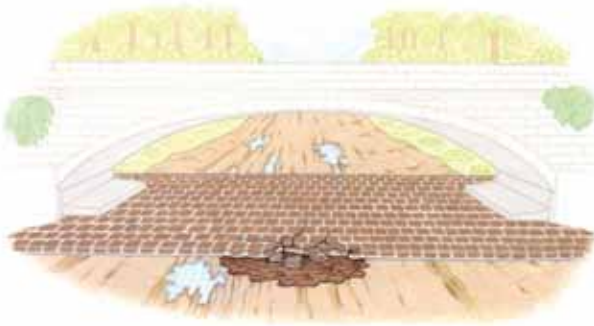

This stone pitched invert has been damaged by river scour.

River training works

River training works are used to keep a river on its path.

There are 4 common ways of river training:

- SHEET PILED WALLS of steel or timber (picture on page [1] -33);
- embankments protected by rip-rap or gabions;
- groynes made from steel or timber piles or gabions;
- trees protected by gabions.

GROYNES are lines of piles or gabions which are placed part way across the river from the river bank.

If trees can be grown, their roots help to keep the bank in place. Gabions are sometimes used to protect the young trees.

River training works can be made of many different types of material and with different methods of construction. If you are not sure about the methods used in your district ask the engineer.

OTHER NATURAL CAUSES OF DAMAGE

Water

As well as the damage caused by water to the river bed, water damages bridges in many ways, for example:

- corrosion of steel in steel bridges (see page [1] - 58);
- corrosion of REINFORCEMENT or PRESTRESSING in concrete bridges (see page [1] - 51);
- DECAY of timber (see page [1] - 77);
- damage to masonry or stone pitching by water running down it (see page [2] - 111);
- abutments and retaining walls can be pushed forward if drains are blocked and water is held behind the wall;
- water running down embankments can wash the fill away. This sort of erosion can be a very serious problem on some types of abutment.

Good DRAINAGE on the approaches to the bridge, and drainage and waterproofing on the bridge, help to avoid these problems.

Some of the drainage is easy to see, such as drains on the deck.

The next picture shows how badly placed deck drains can cause corrosion on a steel girder;



You cannot see drainage behind an abutment, but it is important. If water builds up behind an abutment, the pressure of the water may push the abutment forward.

Usually a bridge abutment has a drainage layer behind the abutment wall, and WEEP-HOLES through the front face of the abutment wall.

Weep-holes are shown on page [1] - 17.

Sometimes there is also a drain along the bottom of the drainage layer which collects the water and carries it out to the side of the abutment.

Debris, dirt and vegetation

When dirt or DEBRIS collect on a structure they hold water, and the dampness causes deterioration. If large plants grow in these pockets of dirt, their roots can damage the structure:



If debris carried by the river collects against a pier or abutment, it can block the waterway. The river may then wash out the road embankment.

If large amounts of debris collect against a pier or the bridge superstructure, the force of the water on the debris can badly damage the bridge.

For many bridges, only part of the waterway is covered by the river for most of the time. Vegetation grows in the areas the river does not use. Grasses and light vegetation (such as rice) are good, as they hold the soil in place. Trees, large bushes and large plants (such as bananas) are bad, as they will block the waterway.

In desert areas, wind-blown sand can block culverts and bridges over dry river beds. When the river flows, the sand may be washed away but the bridge or culvert might be badly damaged.

Earthquakes

Bridges are sometimes damaged by earthquakes. There are 2 common types of damage caused by earthquakes.

- foundation failure causing movements of the abutment or piers;
- the superstructure moving off its supports. Some bridges in earthquake zones have the superstructure held down to stop it falling off.

Landslides

Another danger to bridges is LANDSLIDES. If there is a landslide which blocks the river upstream from a bridge, the water will build up behind it. After some time, the river may break through and wash the bridge away. This does not often happen, but it is always helpful to talk to local people when you inspect a bridge. They can tell you about changes in the river that you might not see from the bridge site.

BRIDGE MATERIALS

The main materials used in bridges are concrete, steel, masonry and timber.

This section describes the problems to look for in each material. In the steel notes, you will also see notes about paint and GALVANISING.

At the end, you will find notes on gabions.

CONCRETE

There are 5 main problems with concrete on bridges:

- cracking of the concrete;
- SPALLING of concrete;
- corrosion of reinforcement or prestressing steel;
- poor quality concrete;
- chemical attack;

These notes on concrete start with some general information about concrete in bridges. Then they tell you about each of these 5 problems.

General

Concrete for bridges is usually made from stones, sand, cement and water. As new concrete dries, it shrinks. This shrinkage is very small.

Concrete is strong in COMPRESSION but weak in TENSION:

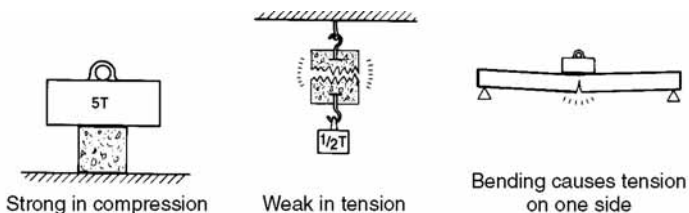

So when concrete has to carry tension, it needs to be made stronger. To give it more strength, steel reinforcement or steel prestressing is fixed inside the concrete.

There are 3 ways of using concrete in bridges:

TYPE	CONTAINS STEEL?	OFTEN USED FOR:
1. MASS CONCRETE	No	Abutments Piers Retaining walls Footways KERBS
2. REINFORCED CONCRETE	Yes: Steel bars	Abutments Piers Decking SLABS BEAMS BOX-GIRDERS
3. PRESTRESSED CONCRETE	Yes: Tensioned steel bars or wires	Slabs Beams Box-girders

Most problems with concrete come from water and air getting into the concrete. Water and air together can cause reinforcement or prestressing steel to CORRODE, but good concrete can protect the steel. Sometimes water and air can carry chemicals which damage the concrete, or corrode the steel more quickly.

If water can lay on a concrete bridge deck, it will get into the concrete. For example a blocked drain can keep water on the deck, which can cause a lot of damage to the concrete.

If deck drains are not properly made and water can get down the side of the drain, or through the concrete around the drain, then the beams underneath may be damaged.

This is shown in the next photograph:



Cracking of concrete

You must try hard to look for cracks all over the bridge, but the engineer will know that you cannot look at some parts. Make a note of the parts you cannot see and the engineer will arrange for a special inspection.

Most concrete has cracks in it. Large cracks are always important, but fine cracks may not be a problem. The next photograph shows fine cracks due to shrinkage. These cracks are not important.



During your training, the engineer or an instructor will show you the kinds of cracks that you should report or sketch.

The engineer may tell you to report all the cracks that you see in some places on a bridge because they are important places, or because the concrete is a special kind, such as prestressed concrete.

To report on cracks, look carefully at them and follow this guide:

1. Measuring cracks:

You need to measure the length and maximum width of the important cracks, and draw them on a sketch of the part you are inspecting.

A crack is important if it is 1 mm wide at the widest part, or if it is found in an important place, like the crack on page [2] - 89. You should carry a simple gauge to measure the width of the cracks. A gauge can be made from steel, like the one in the drawing below.

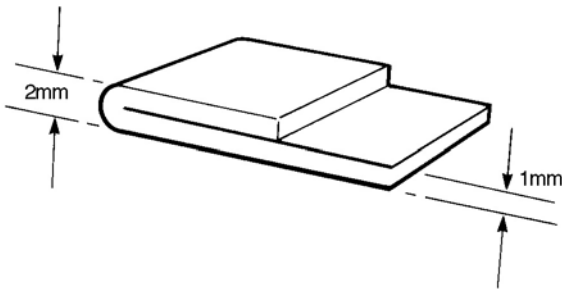

2. If you find a lot of cracks over a large area, you should draw them on a sketch too, even if they are less than 1 mm wide.

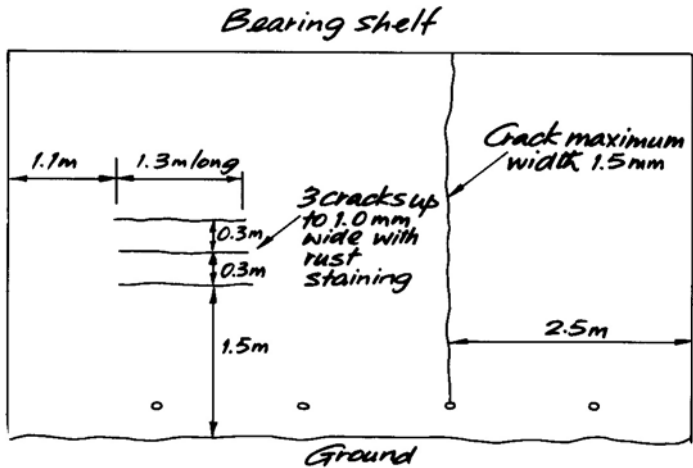

Sketch 1. Elevation of Greton Abutment.

3. If you see any rust staining or any white deposits along the line of cracks, make a note.

4. On the bridge use a waterproof pencil to mark the ends of the serious cracks and write the date of your inspection.

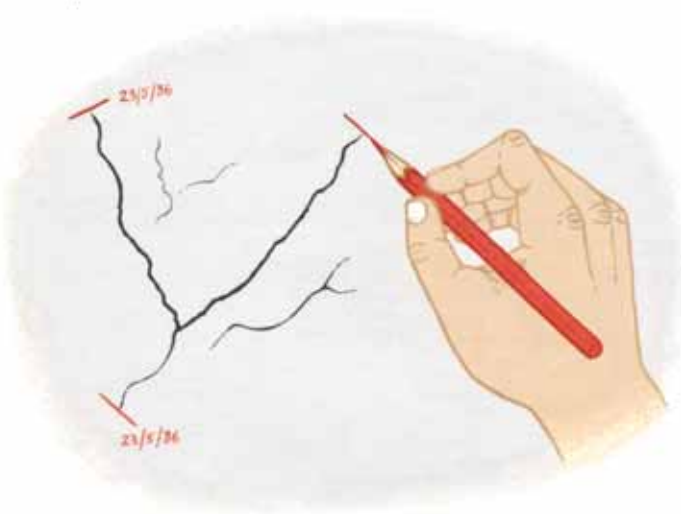

5. If the ends of the cracks were marked at the last inspection, look carefully to see if they are longer now and put a new mark at the end of the crack, and the date.

Spalling of Concrete

Spalling means that some of the concrete has fallen away from the structure.

Spalling is commonly caused by corrosion of the reinforcement. When steel corrodes, the rust is much thicker than the original steel. So when a bar corrodes inside concrete, it breaks pieces of concrete away:



Corrosion of Reinforcement or Prestressing

This is the most important problem with concrete bridges. This can cause the bridge to fail.

Corrosion can be caused by:

- not enough concrete around the reinforcement;
- a break in the concrete due to serious cracking, spalling or HONEYCOMBING (see the 'Poor quality concrete section on page [1] - 53);
- poor quality concrete.

Corrosion will happen more quickly when the concrete is in, or near, salt water.

Signs that the reinforcement may be corroding are:

- you can see the reinforcement at the surface of the concrete;
- you can see cracks or rust stains along a line where you think there is reinforcement;
- you can see areas where concrete has spalled. Where the concrete has spalled, you should measure two things:
 1. Measure the original COVER to the bars. To do this, put a straight-edge across the spalled area, so you can see where the concrete surface was before, and then measure from the straight edge to the nearest part of the reinforcement.
 2. Make an estimate of how much of the bar is corroded away.

If you find signs of corrosion, draw a sketch which shows where the corrosion is. When possible, show the reinforcing bars on your sketch.

Poor quality concrete

There are 3 problems to look for with poor quality concrete:

- water and air can go through the concrete too easily;
- you can see large holes in the surface of the concrete. These holes are called honeycombing;
- chemicals, which you cannot see, in the stream or river may damage the concrete.

It is not easy to know if the concrete is poor without special tests. But if water can get into the top surface of a deck, you may see dampness on the bottom of the bridge deck. This can mean that the concrete is poor or that the drainage is bad. Whatever the cause, the water should be stopped. If the water is not stopped, the deck reinforcement will corrode very soon.

Honeycombing is caused during construction when the wet concrete does not flow properly and air gets trapped in it. The concrete then has holes where the air was trapped. If there is honeycombing, then the concrete cover to the reinforcement will be much thinner than it should be, and the reinforcement may corrode quickly.

This picture shows honeycombing under a bridge deck:



Chemical attack

If chemicals are damaging the concrete the surface of the damaged concrete might feel soft or there might be lots of small hollows in the surface of the concrete. If you think the concrete is being damaged by chemicals write a note for the engineer.

This picture shows bad attack to a concrete pier by chemicals in the river water:



STEEL

Steel bridges need to be inspected for 5 main problems:

- deterioration of paint or galvanising;
- corrosion;
- damage (bends) to steel parts;
- loose fixings;
- cracking.

Deterioration of paint and galvanising

Steel will corrode if it is not protected from air and water. Steel can be protected from corrosion by paint or galvanising. Sometimes, when the risk of corrosion is high, steel is first galvanised and then painted.

Galvanising is a thin layer of zinc on the surface of the steel. It is put on the steel by a special process. In air, galvanising stops the steel from rusting for a longer time than paint. But in salt water, galvanising soon comes off and the steel starts to rust.

Paint or galvanising does not last for many years. When paint or galvanising deteriorates, the steelwork needs new protection. Painted steelwork can be painted again, and galvanised steelwork can be painted with a special zinc-rich paint, or with some other paint made for galvanised steel. Before the steelwork can be painted again, the old paint or galvanising must be very well cleaned and all rust removed, or the new paint will not last long.

Paint deteriorates when the steel starts to rust. Often, the first signs of failure are small spots of rust in the paint surface. These spots of rust allow water to get under the rest of the paint. This causes more rust and the paint starts to come off. Paint deteriorates more quickly where the paint is thin, e.g. at corners or sharp edges in steelwork. Chemicals in the air (from factories) can also cause paint deterioration to happen quickly.

Galvanising deteriorates by corrosion of the zinc. If you see white spots on the surface of the zinc then it is corroding.

If the paint or galvanising on a steel bridge is not properly MAINTAINED the steel will rust.

When you see signs of paint or galvanising failure, make careful notes and sketches. If repairs are carried out quickly, the corrosion can be stopped.

Corrosion (rust)

Corrosion, or rust, is a chemical change which happens to steel when it is in contact with air and MOISTURE.

This photograph shows corrosion at a joint:



If corrosion becomes very bad, the edge of the steel plate can look as if it has split into thin layers. This is called LAMINATION. When this happens, the steel has almost no strength left. It is very serious and you must make a special note to the engineer (see introduction to Part [2]).

Rust is much thicker than the steel that it comes from. Where two pieces of steel are bolted or rivetted together, rust can push the steel sections apart, bend the steel and may even break the bolts or rivets.

On the bridge shown in the photograph below, rust has pushed the concrete deck away from the steel beam:

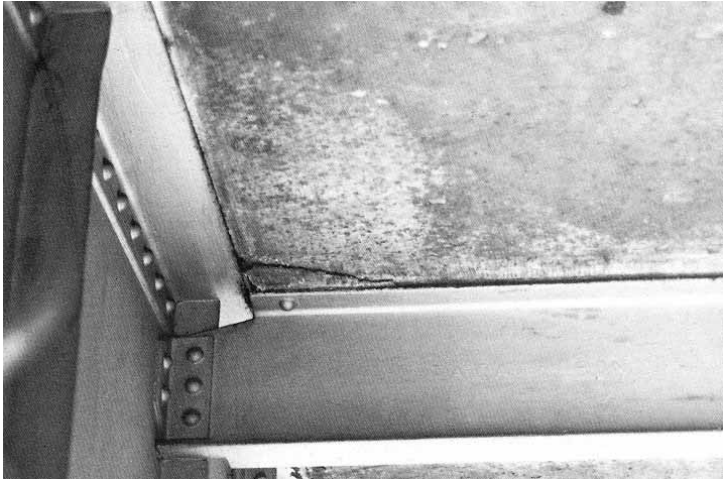

Usually the worst corrosion happens under the deck. Here there is often water from CONDENSATION and sometimes from poor deck drainage. Dirt from the deck and other debris, such as birds' nests, hold the water against the steel. Bird droppings cause corrosion.

Damage to steel parts

When a STRUCTURAL part of a steel bridge is bent, for example by vehicle impact, it may seriously weaken the structure. You must measure the bend. Use a straight edge or a string line as shown in these two pictures. Make a sketch for the engineer, showing which part of the bridge has been damaged. Only the engineer will know if the bend is serious or not.



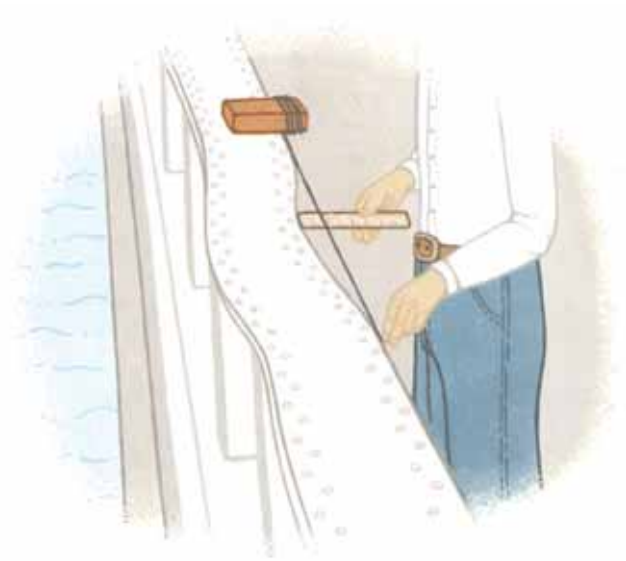

There are four types of steel deck used on bridges – stiffened steel decks, open panel decks, trough decks and steel jack arches.

Stiffened steel decks have **STRINGERS** welded to the underside of the steel plate. The plates usually span 2 or 3 metres between cross girders. Stiffened deck plates may be bent by **OVERLOADED** vehicles. Bends in these plates are serious.

Open panel decks are made of mesh panels or **MARSDEN MATTING**. Because the panels usually span very short gaps and are often used only as a running surface, small bends in these panels are not so important.

Trough decks and steel jack archers span between the main beams or girders and usually have concrete or gravel filling on top of them. If water leaks through the concrete or the bituminous surface, the water gathers at the bottom of the trough or at the edge of the buckle plate where two arches join. This is a common problem and can cause corrosion.

Loose or broken fixings

Steel parts are joined by fixings such as rivets and bolts, or by welding the parts together.

Some years ago, most joints were fixed with rivets. Many old rivetted bridges still exist. In some countries rivets are still used, but bolting or welding is more common now.



All rivets and bolts must be tight and not broken. If there is corrosion between two pieces of steel which are fixed together, the fixings can break. This is because rust is much thicker than the steel it comes from.

This picture shows rivets that could be broken by rust.

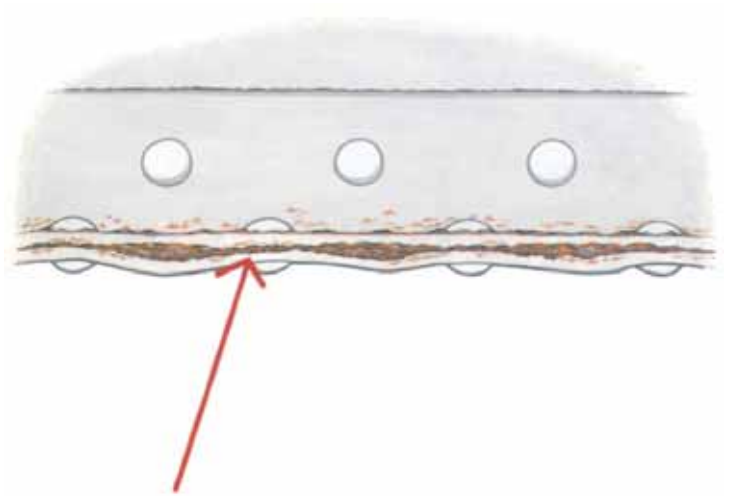

You can easily check that rivets are tight and not broken. Put your finger on one side of the rivet head so that your finger touches both the plate and the rivet head. Then, hit the other side of the rivet head firmly with a light hammer:

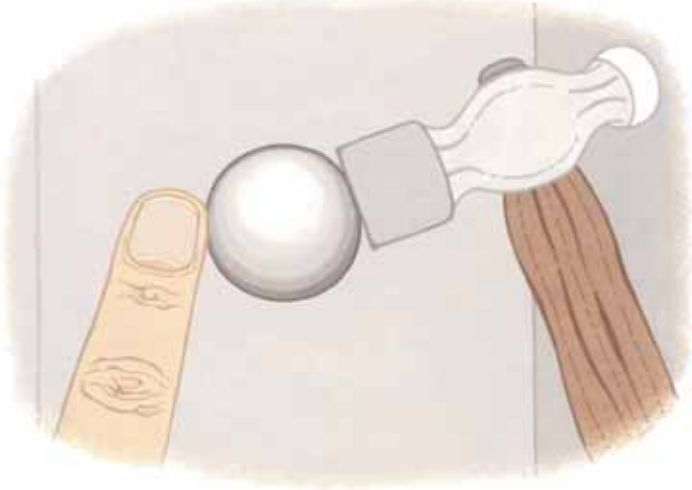

If the rivet is loose or broken, your finger will feel the rivet move.

There are two basic types of bolts; bearing bolts and friction grip bolts. You can tell which are friction grip bolts from markings on the head:

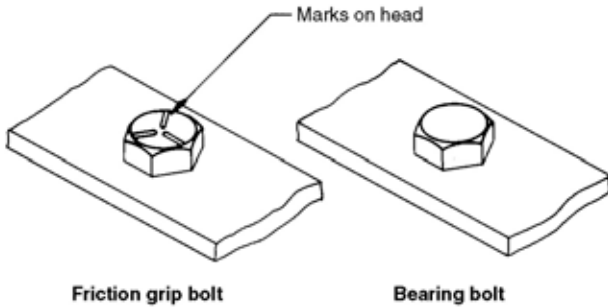

Friction grip bolts are unlikely to work loose, so you do not usually have to check them.

Bolts holding joints near the bottom of a truss or near the road deck are very important. You can check that bolts are tight by using a spanner.



You will not have to check every bolt or rivet on a bridge at every Inspection. The engineer will tell you which joints you must check at each inspection. An example of a joint which should always be checked is where the cross-girders meet the trusses on a half-through truss.

Cracking of steel

Sometimes, but not often, steel members crack. This can be caused by many heavy loads crossing the bridge, or by problems with welds, or by faults in the steel.

Look carefully near all welds, holes etc. This is where cracks can start.

If you think you can see a crack, make a sketch for the engineer, showing the crack and where it is on the bridge. It may only be a crack in the paint, but it should be checked. A crack often has a thin line of rust along it.

MASONRY

There are 4 main problems you may find with masonry:

- cracking;
- bulging;
- poor POINTING;
- deterioration of the bricks or stones.

General

Masonry is bricks or stones with sand and cement mortar in the joints between them. It is strong in compression and weak in tension, like mass concrete.

Masonry is used for constructing abutments, piers and retaining walls. Because it has no steel reinforcement, it is not easily damaged by dampness. Well-maintained masonry structures carrying light vehicles, have lasted hundreds of years. But heavy vehicles can damage masonry by VIBRATION of masonry arches, or by impact to masonry parapets.

Cracking

Cracking is an important sign that something might be wrong with masonry. Cracking can be caused by overloading, vibration or impact from traffic, by failure of the foundation, or by temperature changes or wetting and drying.

Cracking weakens masonry, allows water to run through and allows soil to enter the structure. After a short time, plants and even small trees can start to grow in the cracks. As the plants get bigger, they may make the cracks bigger.

When you see cracks, it is not always easy to know how they happened. All masonry, like concrete, expands and contracts with changes in temperature. Masonry built with some types of brick will also expand as the bricks get wet and contract as the bricks dry out. Cracks caused by temperature or moisture changes often run through the mortar only. Cracks which go through the bricks or stones of the masonry are very serious. These cracks probably mean that the foundations have failed or that the masonry has been overloaded.

In your inspection, note and make a sketch of all large cracks (wider than 5 mm), showing where they are on the bridge; all cracks near the bearings, and all cracks where there is a step caused by cracking in the face of the masonry.

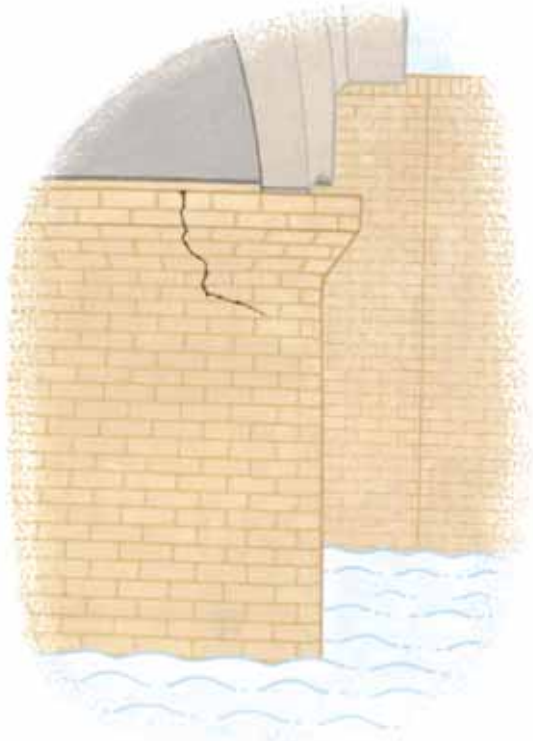

Cracking is 'very serious' if:

- there is cracking near the bearings, as in the picture above;
- there is a step in the face of the masonry;
- the cracks are as big as 10 mm.

Bulging

Bulging is a change in shape or bending of the face of a masonry wall, usually due to soil behind pushing part of the face outwards. It can happen to abutments, retaining walls, or the barrel or spandrel walls of masonry arch bridges. Bulging of masonry parapets can be caused by vehicle impact.

The force from the soil behind a wall can increase due to extra soil being put on top, or the water level in the soil rising (perhaps due to blocked weep-holes), or compaction and vibration due to heavy vehicles, or shaking by an earthquake. Also, as the mortar pointing becomes old, it may become weak, allowing the masonry to bulge.

Make a sketch of any bulges, and measure them with the help of a straight edge or string line.

Poor pointing

Pointing is the mortar between the bricks or stones. The mortar can be worn away by the river or by rainwater running down the face of the masonry. Pointing is usually weaker than the stones or bricks and it will deteriorate with age.

If the mortar pointing is worn away or is in poor condition, the bricks or stones may move or even fall out. This weakens the structure. During inspections, look carefully for poor pointing.

Deterioration of the bricks or stones

Not all masonry will last a long time. Many types of bricks, and some stones, can be worn away by rain or the river, and by the effects of heating or cooling.

To check if the bricks or stones have deteriorated, tap the surface (not too hard) with a hammer. If pieces break off, it may be necessary to protect the surface with a layer of hard mortar, called RENDERING.

TIMBER

Timber has 2 main problems: decay and insect attack. Notes on the special problems with joints in timber bridges come at the end of this section on timber.

General

A tree trunk has 3 layers. On the outside there is bark, which has almost no strength. Next, there is a layer called the sapwood, and in the middle of the tree is the heartwood. The sapwood is usually softer and lighter in colour than the heartwood.

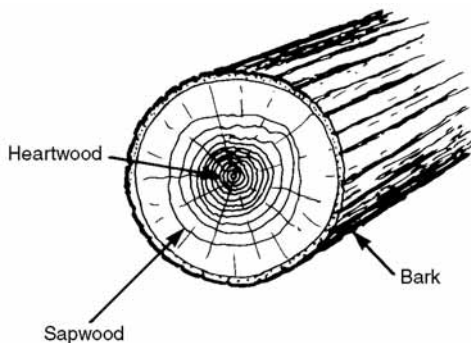

SECTION THROUGH A TREE

Decay and insect attack happens more often in the sapwood, because it is softer.

On some log bridges the bark has not been removed. This is bad, because the bark stays damp and this causes decay. The bark is also a home for many insects. When a log bridge still has bark, you should remove as much of the bark as possible before you inspect it.

Decay

Decay is caused by a FUNGUS which attacks damp wood
Decay makes the timber go soft and lose its strength.

You should look carefully at those places on the bridge which are in contact with both water and air.

For example:

- parts in contact with the ground (piles, ends of beams, logs, etc.);
- places where dirt, debris and water collect and vegetation grows (bridge deck and joints in a truss);
- around fixings. Water can sometimes get to the middle of the timber through holes for fixings. It will be difficult to see this type of decay;
- around splits in the timber. Splits are common and will only lead to decay if water can stay in them, as in splits in the top of horizontal timbers.

Look at the picture below. Split 1 will cause decay, water will not go into split 2.

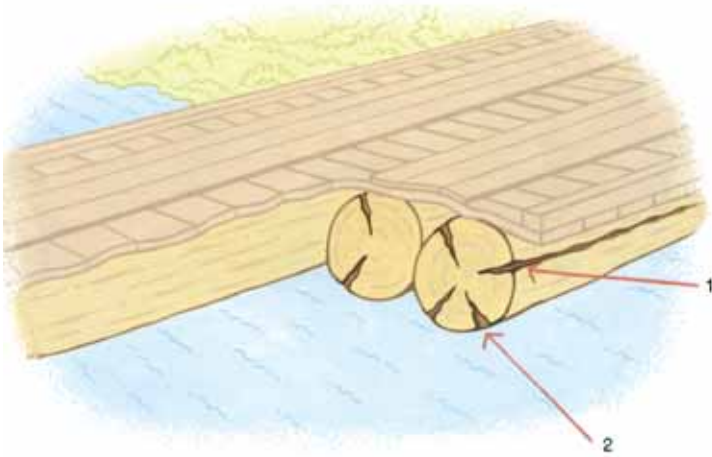

Sometimes, timber is treated with chemicals to prevent decay and insect attack. The chemical will not get into the middle of the timber so, even if the outside of the timber is good, decay may still happen in the middle.

Decay below the surface

You must look carefully and test to see if there is decay in the middle of the timber.



When you are inspecting for decay, you must look for:

- stains on the timber caused by water;
- soft areas on the surface;
- soft areas which are split into small blocks separated by cracks. This is a sign of very bad decay;

- a flat fungus growing on the surface of the timber. It is a sign of bad decay deep inside the timber. Do not remove the fungus.



This type of debris keeps the timber wet and causes decay and fungus attack.

Insect attack

Holes and tunnels in timber made by insects or worms can seriously weaken a bridge. Insect holes usually have dust in them or near them. A few small holes (less than 5 mm diameter) are not usually serious. If there are many larger holes, the problem is serious.

A number of insects attack timber. The most damaging are forest longhorn beetles, which make large holes, and termites, which make large tunnels through the timber. If you see termite nests near a timber bridge you will know there is a danger of attack to the bridge.

In salt water, a worm called the teredo can attack any area below the high tide level. Teredo worms make large holes and can cause very serious damage. You must check all piers and piles in salt water. To test timber in salt water, use the Hammer Test (see below). Hit the timber just above the water.

Tests for decay and insect attack

There are 3 simple tests for decay and insect attack:

- **Spike Test:** To test the surface layer of the timber, push a spike into the wood to find soft spots. Use a square spike so the next inspector does not think your spike holes were caused by insects.
- **Hammer Test:** To test for decay or insect attack inside the timber, hit the timber with a hammer. Decaying timber sounds different from solid timber.
- **Drill Test:** If you think there is decay inside the timber, drill a small hole into the wood. The different feel of drilling into soft wood will tell you if there is decay. Be careful not to make too many holes near joints. The pin or bolt holes at joints are already the weakest part of the timber. A 5 mm drill is big enough for this test.

After using the spike or drill test, put some creosote, or other preserving chemical, into the hole. Fill drill holes with wood plugs.

Joints in timber



There are 3 points to remember about joints in timber:

- Shrinkage in timber or vibration from traffic can make bolts in joints loose. All bolts should be checked for tightness.
- Some bridges, like the timber deck truss bridge shown above, have decks which are 'nail laminated'. The timbers are all nailed together with no gaps. These decks are often used on timber truss bridges.

For some bridges with nail laminated decks, the connection between the deck and the truss is very important for the strength of the bridge. This connection must be checked from below, to see that the deck is tightly nailed to the top member of the truss.

- The joints in timber are often made with steel plates, bolts and pins. These steel parts must also be checked. You should look for loose pins and damaged or corroded bolts, pins or plates.

GABIONS

Gabions are wire baskets filled with stones.

Most gabion baskets are 2 metres x 1 metre x 1 metre in size. For scour protection a thinner, larger gabion is sometimes used. This is called a reno mattress. Reno mattresses are usually not more than 0.5 metres thick.

The baskets can be tied together with wire to form retaining walls. Gabion retaining walls can bulge without damage to the gabions.

Baskets can be tied together to form mattresses to cover large areas of slopes or river beds. Gabion mattresses can change shape a lot without damage. This makes them specially useful for protecting abutments, piers and road embankments against scour. As the river scours, the gabions settle into a new position, but still protect the abutment pier or embankment.

For simple bridges, gabion baskets can be tied together to make an abutment. If the gabions change shape, this may not damage the gabion abutment, but any SETTLEMENT of the abutment can damage the deck.

The next picture shows a simple log bridge being built on a gabion abutment:



There are 2 main problems with gabions:

- the wrong sort of stones in the baskets;
- corrosion or damage to the basket wires or the tie wires.

The wrong sort of stones in the baskets

If the stones inside the baskets are too small, the wrong shape, or the wrong material, the baskets will not hold them and the gabions will fail.

Corrosion or damage to basket wires or tie wires

Basket wires and tie wires are galvanised or coated with plastic, but they will corrode after some time. If they corrode badly, they may break. Basket wire and tie wires can also break if the gabions change shape too much. Wires and ties can also be broken by debris in the river.

If the wires and ties break, the stones may be washed away. However, plants may grow in soil between the stones and help to keep stones in place, even when the wires have corroded.

CULVERTS

A culvert is used to take a stream or small river under a road. The picture below shows a simple culvert with one barrel.

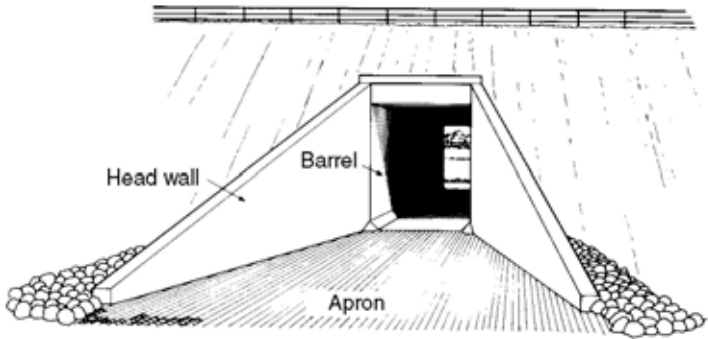

Sometimes, culverts have 2, 3 or more barrels, as in the photograph shown on page [2] - 119.

Culverts can be made from timber, concrete, masonry or steel, and are inspected just like small bridges, but using the CULVERT page of the report form.

Because culverts are small they can easily be blocked by debris. Unlike bridges, culverts can run full of water during a flood. The force of the water may then do a lot of damage to the HEADWALLS and aprons.

Culverts may be made of small pipes, like the one in the picture below. They may have no headwalls and no aprons. Even small pipe culverts are important because they are part of the drainage system that keeps the road base strong.



PART (2) – THE INSPECTION

INTRODUCTION

Now that you have read and you understand Part [1] of this book, you are ready to inspect bridges. For each inspection you will use a report form. Your first inspections should be with an engineer, so that you can ask questions and learn how to use the report form.

BEFORE YOU GO

Before you go, look at a copy of the bridge record card for the bridge you will inspect and the last inspection report form, if there is one.

The bridge record card has details of the bridge you are to inspect: where it is, how long it is, and what type of bridge it is. It will also have a drawing or photograph to help you know it when you get there. Some details on the bridge record card must be written on the report form before you leave the office. These are listed on page 2 of the form. You will check that they are right when you get to the bridge.

The last report form will tell you what problems were found during the last inspection. You should look carefully to see if these problems have got worse. The notes and sketches will help you to measure the problems.

You should check in the office to find out if any maintenance has been done on the bridge since the last inspection. You should look on the bridge or in the river to see if the maintenance has been done well, and to see if it has solved the problem.

There may be other notes in the office that be useful to you. For example, there may be a report of an earthquake or a flood in the area of the bridge, or a complaint from drivers that some damage has been done. You should make a note and remember these things when you make the inspection.

Before you go, make sure that you have all the equipment that you will need. Appendix B has a list that you can use. Change the list to suit the way you work and use it each time before you go.

THE INSPECTION

The following notes follow the order of the inspection report form in Appendix D at the end of this book.

Appendix D is a completed report form to show you how a finished form will be. Look at it to see how an inspector should work, but remember that you must fill in your report form to show what you have seen. The ticks you make may be in different boxes to the ticks shown in Appendix D.

Report form page 1:

Arriving at the bridge

It is easy to make a mistake and inspect the wrong bridge.

CHECK that you are at the right bridge:

- **Check the bridge number.**
- **Check the bridge name.**
- **Check the distance from the beginning of the road, or use the kilometre posts.**

These three things to check are at the top of page 1 of the report form.

* * *

Read carefully the INSTRUCTIONS FROM THE ENGINEER TO THE INSPECTOR.

* * *

On the small sketch of the bridge write the names of the towns or villages on each side of the bridge. Mark which way the river flows, and write numbers on the spans and piers (if there are more than one). Call abutments by the names of the town or village nearest to that end of the bridge. The engineer must know which part of the bridge you are reporting on. The sketch will help. As an example the sketch might look like this:

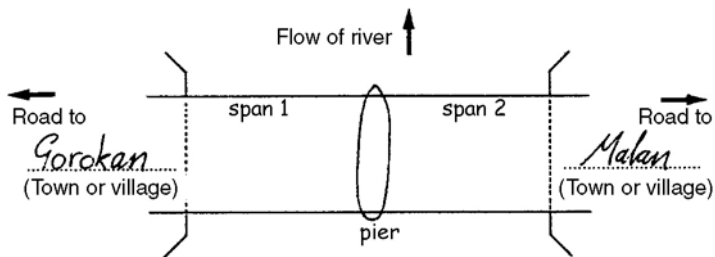

* * *

At the end of the inspection

When you have finished inspecting the bridge, look carefully at your report:

- Have you filled in all the sections?
- Have you made all the notes and sketches that you need to?
- Have you numbered all your notes and sketches?
- Have you written these numbers in the correct place on the form?
- Will the engineer be able to understand?
- Are there any problems not on the form, which you should tell the engineer about by writing a note?

When you are sure you have finished, sign the report form at the bottom of page 1. Also write the date of the inspection and the number of pages in your report. Make sure that the pages, including any notes and sketches, are fixed together. Then take it back to the office for the attention of the engineer.

* * *

Report from page 2:

Construction details, Services and Signs

CONSTRUCTION DETAILS

CHECK each construction detail as well as you can and tick it as CORRECT: YES or NO.

* * *

SERVICES

The report form lists any SERVICES fixed to the bridge. These are electricity or telephone cables (as in the picture below), or gas, water, oil or sewage pipes.



CHECK that the service is still there. Tick under YES if it is, or tick under NO if the service has been taken away.

* * *

Check for new services. If you find any new services that are not written on the form, write a note to say what new services are there and say if they cause a problem.

CHECK for damage to services. If there is a problem make a note on the form, especially if it can damage the bridge. For example a leak from a waterpipe can cause deterioration.

Write a note if you can see damage to the bridge by the Service Authority.

SIGNS

Signs are very important. They may give limits on height, width, weight and speed. The bridge can be badly damaged and may fall if a vehicle hits part of it or if a very heavy vehicle overloads it. Drivers must be able to read the signs.

Page 2 of the report form has a list of all the signs which should be on or near the bridge.

CHECK that each of the signs is still there. Tick under YES if the sign is still there or tick under NO if you cannot find it.

CHECK for damage to the signs. Make sure each sign is still fixed firmly and that it can still be read by drivers. Make a note of any damage on the report form.

Make a note if you find any signs that are not written on the form.

Report form - Page 3 onwards

The main part of the form, from page 3 to the end, is a list of problems you must look for. These problems come under different sections. For example, in 'The River' section you will report on Scour, Blockages in the Waterway and Change of River Path.

You must fill in the report form at the same time as you inspect the bridge. To fill in the report form, you do not have to write very much. Each line will tell you what to look for. Read it carefully and then examine the bridge and decide which box to tick for that line. You may also need to write a note or draw a sketch, so that the engineer will understand what you have seen.

For every line on the report form there is a note in Part [2] of this book. To the left of each problem, in the first column on the page, you will see a page number. This tells you where to look for help in your inspection of that problem. If you need more help, you can look back at Part [1] again. The CONTENTS page at the beginning will help you find which chapter you want in Part [1].

To fill in the form, the first thing you must do is tick either 'Yes' or 'No' to the right of the problem you are looking at, like this:

Handbook page (2)	SUPERSTRUCTURE SPAN No.	Problem		How bad ?			How much ?		Note or sketch reference
		No	Yes	Not very bad	Bad	Very serious	Not much	Some	
	POSSIBLE PROBLEM								

50 STEEL TRUSSES

Deterioration of paint or galvanising ?	<input checked="" type="checkbox"/>								
---	-------------------------------------	--	--	--	--	--	--	--	--

Remember, all the things listed on the form are problems. If there is no problem tick the 'NO' column. If you have ticked 'Yes' (yes, there is a problem), the next thing you must do is decide how bad this problem is. There are 3 possible answers to this question. The problem can be either 'very serious', 'bad', or 'not very bad'. You must tick one of them, like this:

Handbook page (2)	SUPERSTRUCTURE SPAN No.	Problem		How bad ?			How much ?		Note or sketch reference
		No	Yes	Not very bad	Bad	Very serious	Not much	Some	
	POSSIBLE PROBLEM								

50 STEEL TRUSSES

Deterioration of paint or galvanising ?	<input checked="" type="checkbox"/>	<input checked="" type="checkbox"/>							
---	-------------------------------------	-------------------------------------	--	--	--	--	--	--	--

In the last example the problem was not very bad, so the tick goes under 'not very bad'.

The next thing you must do is decide how much of this problem there is. There can be 'a lot', 'some', or 'not very much'. You must tick one of them like this:

Handbook page (2)	SUPERSTRUCTURE SPAN No.	Problem		How bad ?			How much ?		Note or sketch reference
		No	Yes	Not very bad	Bad	Very serious	Not much	Some	
	POSSIBLE PROBLEM								
50 STEEL TRUSSES									
	Deterioration of paint or galvanising ?		✓	✓					✓

In this example there was a lot, so the tick goes under 'a lot'.

The answers under 'How bad' and 'How much' depend on your experience and your judgement. It is important that the engineer understands what you mean. Your first inspection should be with the engineer. Make sure you learn from him how to answer the 'How bad?' and 'How much?' questions.

For example, if you find **a lot of cracks** over a **large area** on the face of an abutment, fill in the form like this:

Handbook page (2)	ABUTMENT, WING WALLS AND RETAINING WALLS ABUTMENT NAME POSSIBLE PROBLEM	Problem		How bad ?			How much ?		Note or sketch reference	
		No	Yes	Not very bad	Bad	Very serious	Not much	Some		A lot
82 ABUTMENT, WING WALLS AND RETAINING WALLS										
89 CONCRETE ABUTMENTS, WING WALLS AND RETAINING WALLS										
Cracking ?			✓			✓			✓	

If you find that a **small part** is **very badly damaged**, fill in the form like this'

Handbook page (2)	DECK AND PARAPETS POSSIBLE PROBLEM	Problem		How bad ?			How much ?		Note or sketch reference	
		No	Yes	Not very bad	Bad	Very serious	Not much	Some		A lot
27 PARAPETS, RAILINGS AND GUARD RAILS										
Impact damage ?			✓			✓	✓			

On parts where 'not very bad' damage is not important at all, the box has been covered up.

In this case you need only tick when you see 'bad' or 'very serious' damage.

Handbook page (2)	THE RIVER BED POSSIBLE PROBLEM	Problem	How bad ?		How much ?		Note or sketch reference			
		No	Yes	Not very bad	Bad	Very serious		Not much	Some	A lot

105

BED PROTECTION

109 RIP RAP BED PROTECTION

Loss of rip-rap ?	<input checked="" type="checkbox"/>	<input checked="" type="checkbox"/>	<input checked="" type="checkbox"/>	<input checked="" type="checkbox"/>	
-------------------	-------------------------------------	-------------------------------------	-------------------------------------	-------------------------------------	--

Sometimes you will need to write a note as well. For example: writing the location of a problem (where it is). If you can, write this on the same line as the problem, like this:

Handbook page (2)	SUPERSTRUCTURE SPAN No. POSSIBLE PROBLEM	Problem	How bad ?		How much ?		Note or sketch reference			
		No	Yes	Not very bad	Bad	Very serious		Not much	Some	A lot

59

UNDERSIDE OF DECK

59 CONCRETE

Cracking ?	<input checked="" type="checkbox"/>	<input checked="" type="checkbox"/>	<input checked="" type="checkbox"/>			<i>Mostly at Goroan end.</i>
------------	-------------------------------------	-------------------------------------	-------------------------------------	--	--	------------------------------

If there is not enough room for your note in this space, write the note on the back of the form page, and give it a number. Write this number in the space on the form, on the same line as the problem.

If you need to draw a sketch, draw it on the back of the page, or a new piece of paper. Give the sketch a number and write this on the form, on the same line as the problem.

The form might look like this:

Handbook page (2)	SUPERSTRUCTURE SPAN No.	Problem		How bad ?		How much ?			Note or sketch reference
		No	Yes	Not very bad	Bad	Very serious	Not much	Some	
	POSSIBLE PROBLEM								
59	UNDERSIDE OF DECK								
59	CONCRETE								
	Cracking ?		✓		✓			✓	mostly at Corvican end see sketch 2.

Take your time and fill in each line of the report form carefully as you come to it. **Remember that you must fill in the form at the time you are looking at the problem. Do not wait until later.**

Sometimes it is very difficult to know the answers, even experienced inspectors may not be able to tell. If you do not know how bad or how much, or if you are not sure if there is a problem, make a note.

Each section of the form has a heading such as UNDERSIDE OF BRIDGE. When you have answered all of the questions under the heading, tick the 'ALL CHECKED? - YES' box. If you could not properly check all of this part, answer as many questions as you can, but also tick the 'NO' box after 'ALL CHECKED?' to show that this part is not completely checked.

All checked

Yes		No	<input checked="" type="checkbox"/>
-----	--	----	-------------------------------------

ROAD APPROACHES AND DECK

ROAD SURFACE NEAR BRIDGE



If the road surface near the bridge is very bad, vehicles bounce up and down as they cross the bridge. This bouncing can damage the bridge.

CHECK for bumpy road surface. On the report form make a note if the road surface is bumpy for up to 50 metres on either side of the bridge. Look carefully at the area behind the ballast wall of the bridge. There is often a pothole here.

DRAINAGE

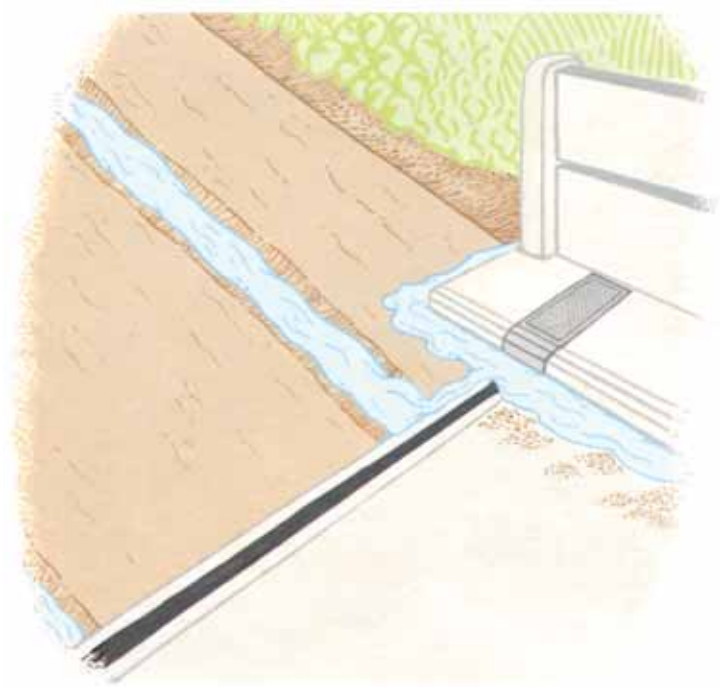

Drainage is important because if water runs on to the bridge deck it may damage it. Water can also carry small pieces of stone which may fall into the expansion joints and damage them. Water from the road can erode the approach embankment.

CHECK for badly built road drainage near the bridge.

Look on both sides of the bridge. Note where the drainage is bad.

* * *

CHECK for blocked or damaged road drains.

* * *



CHECK to see if there is water lying on the deck.

* * *

If water remains on the deck, it can be a safety hazard and may cause corrosion and decay.

CHECK for blocked or damaged deck drains. If you can see deck drains under the deck but not on top, they could be covered by bitumen surfacing. Make a note if the deck drains are blocked by road surfacing.

* * * * *

BRIDGE SURFACE & FOOTPATHS

The road surface on the bridge can be sealed with bitumen, or made of concrete, steel or timber. There is a different section of the report form for each surface.

If the footpath is the same surface as the road, report on the road and footpath together. If the footpath is a different surface from the road surface, then report on the road surface and footpath surface separately. Note on the form which is the footpath.

BITUMEN SURFACE

At deck joints where very small movements are expected, the surfacing may cover over the joint. Often the sealed surface cracks or breaks-up over these joints. Surfacing is often damaged at joints.

* * *

CHECK if the surface is breaking-up or lifting off the concrete underneath. Look very carefully near the expansion joints and near the drain holes.

* * *

CHECK for cracking of the surface above buried joints.



Some modern bridges have a waterproof layer between the concrete and the sealed surface. The bridge record card will tell you if a bridge has a waterproof layer. If the bridge deck surface is in good condition, you cannot see this waterproof layer. When the sealed surface is broken, the waterproof layer may be damaged.

If you see any signs of damage to the waterproof layer, write a note for the engineer.

* * *

CONCRETE SURFACE

CHECK for cracking of the concrete. Look again at the notes on page [1] - 47 if you are not sure how to do this.

On long span truss bridges look carefully for cracking of the concrete decks. Any cracks which begin in spalled areas of the deck are serious.

* * *

CHECK for spalling of the concrete.

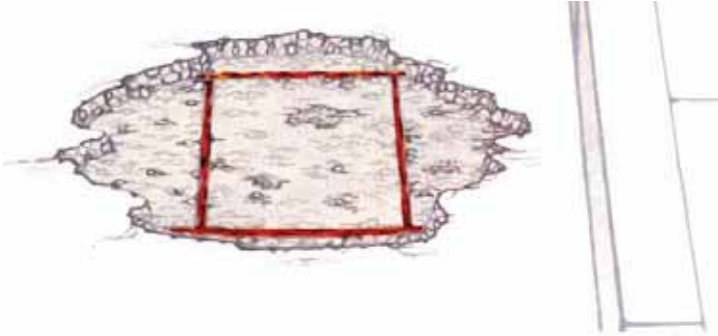

* * *

CHECK if reinforcement is exposed. If it is measure and make a note of the original concrete cover to the reinforcement bars. Also, measure and make a note of how much of the reinforcing bar diameter has been lost. (More notes on this are on page [1] - 52 in the first part of this book).

* * *

Check for poor quality concrete. Look for honey-combing and other signs of poor quality concrete.

* * *

If the road to the bridge is not surfaced with bitumen, small stones in vehicle tyres can damage the surface of the concrete.

CHECK for wear of the surface due to small stones in tyres.

* * *

STEEL SURFACES

There are two types of steel surface:

- Stiffened steel panels.
- Grid or open panels such as Marsden matting. This is shown in the photograph.



* * *

CHECK to see if the fixings are loose or damaged.

* * *

CHECK for bends in the steel panels. For Marsden matting, only make a note of bad bends. On other decks note all bends.

* * *

CHECK for corrosion of the steel surface. Look carefully at areas near kerbs and deck drains.

* * *

TIMBER SURFACE

Dirt, debris and plants in corners and between the boards hold water in the timber. This will damage the deck.

CHECK for dirt or plants growing between the boards.

Look carefully close to kerbs or running strips.

* * *

CHECK for decay of the deck timber. Look carefully near the deck ends and against kerbs and running strips.

* * *

Check for signs of insect attack. Look at all parts of the timber deck.

* * *

CHECK for splitting of timbers. For deck timbers, small splits are not important, but larger splits should be reported.

* * *

Loose deck timbers are very dangerous on any bridge and could cause an accident.

On some bridges, the deck timber helps to strengthen the whole bridge. On these bridges it is very important that the deck fixings are good. The engineer will tell you if you are inspecting this kind of bridge.

CHECK for loose or damaged fixings.

* * *

TIMBER RUNNING STRIPS

Timber running strips are often damaged, and must be replaced with new running strips.

Damaged or loose running strips can cause bad accidents.

CHECK for damage (decay, insect attack, splitting) to the running strips.



This timber deck shows bad decay in some cross members and running strips in very bad condition.

* * *

CHECK for loose or damaged fixings.

* * *

RAILWAY OR TRAM RAILS

Rail or tram tracks sometimes cross road bridges. The rails can work loose, especially near expansion joints. If this happens, the bridge deck can be badly damaged as the train or tram bounces over the loose rail.

CHECK for loose rail fixings.

* * *

KERBS

Kerbs separate the road from the footpath. They are often hit by vehicles.

On some bridges high kerbs are used to stop vehicles driving onto the footpath. These high kerbs are sometimes used instead of guard rails.

CHECK for damaged or loose kerbs.

* * *

FOOTPATHS

Damaged paving slabs or boards can be a danger for people walking across the bridge.

CHECK for damaged footpaths.

* * * * *

PARAPETS, RAILINGS AND GUARD RAILS

If the bridge you are inspecting does not have a parapet or railing, tick the 'ALL CHECKED - NO' box and write a note to say if it was not built, or if it was taken away.



Parapets and crash barriers can be damaged by vehicles. Sometimes, the bridge is also damaged near the parapet.

CHECK for impact damage to parapets. Make a note if the bridge next to the parapet is also damaged. Look at holding down bolts at post bases, joints in rails, and joints between rails and posts.

* * *

CHECK for loose or damaged fixings.

* * *

CHECK for loose post bases where steel, aluminium or timber parapets are set in holes in concrete.

* * *

The next sections are about parapets made of particular materials.

Sometimes, parapets are made of two materials. For example, if there are concrete posts with steel rails, report on the posts using the concrete section and the rails in the steel section.

STEEL or ALUMINIUM PARAPETS

CHECK for damaged galvanising or paint.

* * *

CHECK for corrosion.

* * *

CONCRETE PARAPETS

CHECK for cracking.

* * *

CHECK for spalling of the concrete. Look carefully at the corners of the posts and rails.

* * *

CHECK for corrosion of reinforcement. Look where concrete has spalled. Look for rust stains from cracks, especially near the corners of the posts and rails.

* * *

CHECK for poor concrete.

* * *

TIMBER PARAPETS

CHECK for decay, especially at the base of the posts and at joints between posts and rails.

* * *

CHECK for insect attack.

* * *

CHECK for splitting of timber.

* * *

MASONRY PARAPETS

Masonry, whether brick or stone, damages easily if vehicles hit it. Often it cracks and may be pushed outwards.

Small cracks in masonry are not usually important.

CHECK for serious cracking.

* * *

CHECK for outward movement or bending of the parapet.

* * *

CHECK for poor pointing.

* * *

CHECK for deterioration of the bricks or stonework of the parapet.

* * * * *

EXPANSION JOINTS

There are many different sorts of expansion joints that can be used on bridges. It is a good idea to check the bridge record card in the office, before going out to the bridge, to find out what sort of joint is used and where the joints are on the bridge.

If you look at the bridge record card, you must also look carefully for other joints on the bridge. The bridge record card could be wrong.

The next five checks can be done from above, as you stand on the deck, but remember the joints when you go under the deck. Look for signs of problems and listen when vehicles pass over the bridge. You might hear the sound of loose plates or see signs of damage.

CHECK for damage to the concrete of the deck end or ballast wall near to the joint.

* * *

Joints on long bridges sometimes have several moving parts. Stones or other debris can stop some of the parts from moving.

CHECK for debris or vegetation in the joints.

* * *

CHECK for loose or damaged fixings. With steel parts, this is a common problem.

* * *

CHECK for damage or corrosion to metal parts of the joint.

* * *

Some joints have a rubber water-bar to stop water and debris from the deck falling through the joint. Stones falling into the joint can cut the water bar.

CHECK for damage to the rubber water-bars.

* * * * *

THE RIVER

You must look very carefully for changes in the river. You will be able to see most problems from the deck of the bridge or standing under it by the abutments. Sometimes you may have to walk along the banks for a short distance to check what is happening to the river.

BLOCKAGES IN THE WATERWAY

The waterway under a bridge should be clear. Any blockage is bad because:

1. it can make the water scour a hole in the river bed; and
2. debris can get stuck on it and make a bigger blockage.

CHECK that debris carried by a flood has not piled up against piers or abutments blocking the waterway.

* * *

Sometimes, when a new bridge is built, the old bridge is not all taken away. Parts of the old bridge can catch debris or cause the river to scour holes around the new abutments.

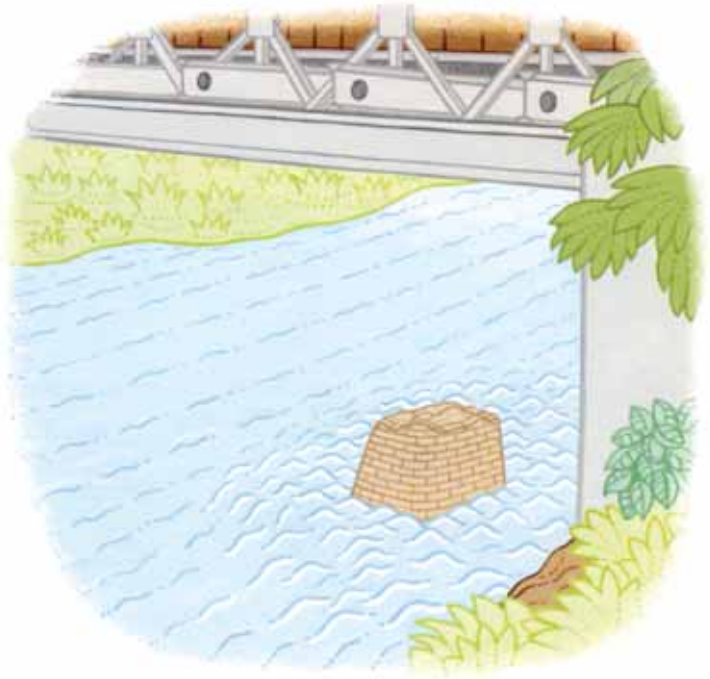

CHECK that the waterway is not affected by the remains of old bridges under the bridge or just upstream of the bridge.

* * *

For many bridges, some of the waterway is usually dry, except in a flood. Sometimes, people put fences and buildings on the dry areas of the waterway. These must be taken away because they will block the waterway. The dry areas of the waterway are often covered with grass and small plants, such as rice. These are not a problem. Large plants and trees, such as bananas, can block the waterway in a flood. They must be taken away.

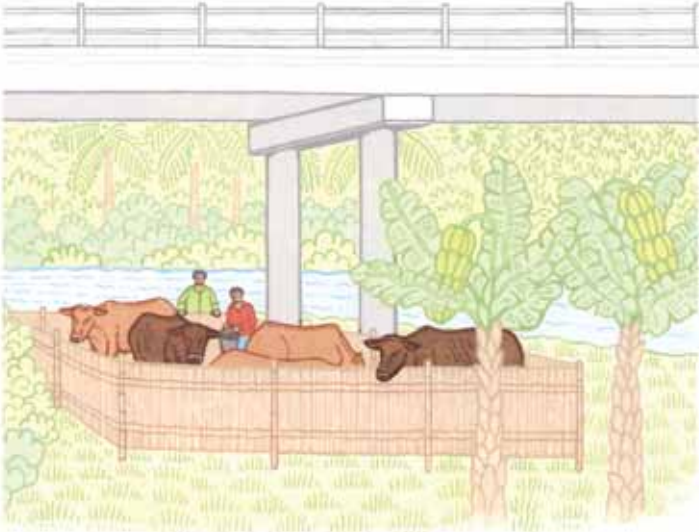

CHECK that there are no fences or buildings of any sort under the bridge, or just upstream in the waterway.

* * *

CHECK that there are no trees or bushes growing under the bridge or just upstream in the waterway, or where a flood can wash them under the bridge.

* * *

CHANGE OF RIVER PATH

If the river changes its path it can destroy the bridge.

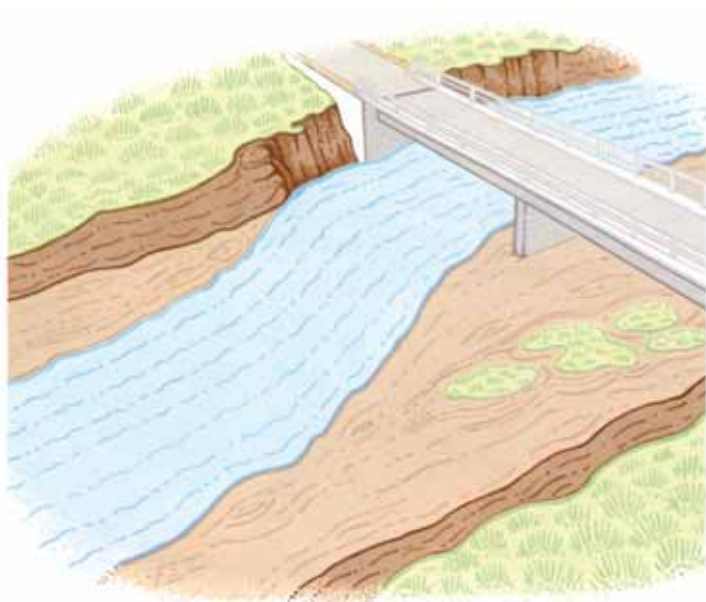

CHECK if the river is changing its path upstream from the bridge.

To find out if a river is changing its path:

- Ask the local people.
- Look at the bends in the river upstream from the bridge.
- Look at the river banks on the bends.

Usually you can see far enough upstream from the bridge. Sometimes you may need to go upstream a short distance.

If the bank is steep and there are trees at the edge of the bank, but nothing is growing on the bank, then the river is moving towards that bank. When there is a lot of water flowing and the bank is not steep and has small plants growing on it and some mud or small stones on it, then the river is moving away from that bank.

* * *

You must also look for other changes upstream of the bridge. If new islands form, then the river may change its path and may damage the bridge.

CHECK to see if new islands are forming. Look to see if there is debris in the river. Debris can cause a new island to form.

* * *

RIVER TRAINING WORKS

Two things can go wrong with river training works.

- The river can move beyond the upstream end of the river training works and attack the end of the works.
- The materials of the works may be damaged.

CHECK for river attack beyond the upstream end of the river training works.

* * *

Piles may move forward with scour or be damaged by floating logs. Timber piles may decay, steel piles may corrode.

CHECK for damage to sheet piled walls.

* * *

Rip-rap can sink into a soft river bed, or be washed away.

CHECK for loss of rip-rap.

* * *

Groynes made of gabions, or fencing can be washed away or damaged.

CHECK for damage to gabions, timber fencing, etc.

* * *

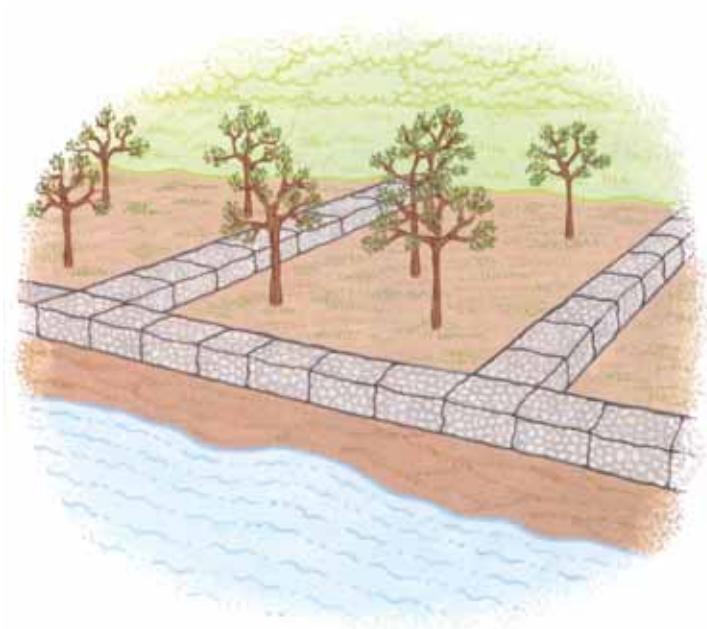

One type of river training uses trees to train the river. The trees are protected with gabions while they grow. Dead or damaged trees must be replaced.

CHECK for damage to trees used in river training works.

* * * * *

SUPERSTRUCTURE

The report form asks you to look at some general problems of bridge superstructures first. You then look at the main supports (beams, slab, girders or trusses), whether they are above or below the deck. Sometimes, to inspect a bridge properly, you will have to look at the same part of the bridge (such as a truss) from above the road and below the road.

Finally, you look at the problems under the bridge deck.

You must repeat this inspection and fill in a new part of the report form for each span.

GENERAL

Bridges are often damaged by vehicles hitting the girders or trusses. Even small bends in girders and trusses can be serious. Sometimes, during a flood, a boat, log or other floating debris hits a bridge and damages it.

CHECK for impact damage to beams, girders, trusses or bracings by vehicles, boats or logs. Make a note of how you think the damage was caused.

* * *

CHECK for debris or vegetation on beams, girders, trusses, bracings or in joints. These can cause serious damage to the bridge.

* * *

If the underside of the bridge deck is wet, this can damage the bridge.

CHECK that there is no water coming through the bridge deck, except through proper drains.

If the underside is not wet, there may still be a problem. You need to look for signs that the underside has been wet before:

- On steelwork, look for rusty marks.
- On timber, look for dark water run marks.
- On concrete, look for dark areas and a build up of white material on the surface.

* * *

CHECK that water from the deck drainage does not flow on to the girders, trusses, beams or bracings.

* * *

For a bridge which carries a road over another road, it is important that there is enough headroom.

When a road is resurfaced, too much bituminous surfacing may be put on, so that the headroom to an overbridge is too small. If the road has been resurfaced since the last inspection:

CHECK for enough headroom for an overbridge

Measure the headroom where it is smallest, from the surface of the road below to the underside of the bridge superstructure. Write the headroom in the box on the form.

* * * * *

MAIN BEAMS, GIRDERS, TRUSSES AND BRACINGS

CONCRETE BEAMS

CHECK for cracking of the concrete. If you find cracks, measure the length of the crack and its width at the widest point. Make a sketch of the crack and include it with the report. Mark and date the end of the crack. Look to see if any cracks have got bigger since the last inspection.

Look carefully for:

1. Cracks at the beam ends which spread up from the bearings as in the picture below. These are a serious problem.

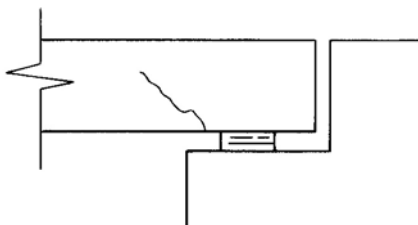

2. Cracks on the face of beams which are parallel to the bottom of the beams. These cracks can happen when the corner of the beam is starting to spall. Look carefully at these cracks and tap the concrete firmly to see if it is spalling. Mark the ends of the crack and make a sketch of it.

* * *

CHECK for spalling of the concrete.

* * *



This picture shows spalling of the concrete due to corrosion of the reinforcing steel.

CHECK for signs of corrosion of reinforcement. If any reinforcement is visible, measure and make a note of the concrete cover to the reinforcement. Also, measure and make a note of how much of the reinforcing bar has been lost.

* * *

CHECK for signs of poor quality concrete. Look especially at the bottom corners of deep concrete beams:



* * *

STEEL GIRDERS AND BRACINGS

This drawing names the parts of a steel girder.

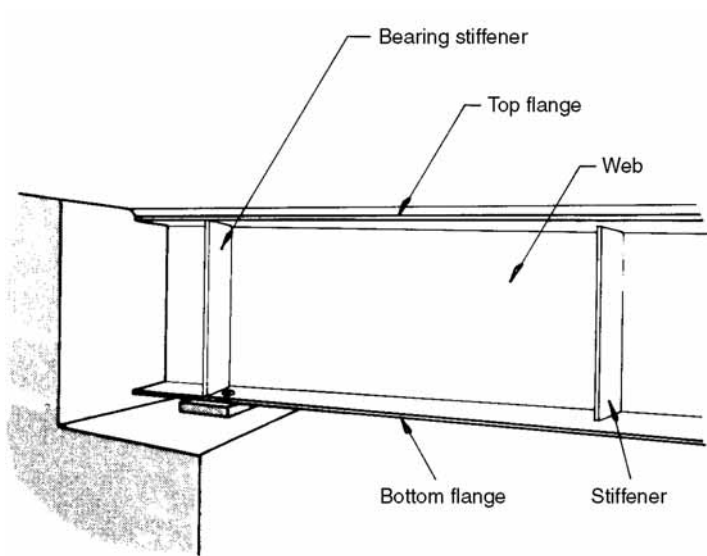

CHECK for deterioration of paint or galvanising, on all main girders and cross girders.

* * *

CHECK for corrosion of the steel. Look everywhere, but especially at any wet areas. On many bridges there is debris on the bearing shelf and this keeps the area wet. Look very carefully at the girder ends. Many steel girder bridges corrode badly at the ends near the bearings. The next photograph shows bad corrosion at the end of a girder:



Two very serious problems caused by corrosion are:

- Laminations in steel (see page [1] - 58).
- Steel sections joined by rivets or bolts being forced apart. If this has happened check all bolts or rivets in the joint. Write a note if you see lamination or other damage caused by corrosion.

* * *

A big overload can cause a bend along most of the girder. You can see these bends by looking along the edge of the girder flange. Bends in the beams or girders are serious. Also look for bends in the STIFFENERS above the bearings. Make a sketch of the damage and show which part is damaged.

CHECK for bends in webs and flanges of girders, and in stiffeners and bracings.

If possible, measure the size of all bends. Place a straight edge or string line next to the damaged member and measure from this to the girder.

* * *

CHECK for loose bolts or rivets. On the structure mark all loose bolts or rivets with a waterproof pencil or paint. Make a sketch of the girders and mark the joints which have loose bolts or rivets.

* * *

CHECK for cracking, especially at welds and holes. If you find any cracking write a note to say where the cracking is on the girder and draw a sketch. Cracking can be very dangerous.

* * *

STEEL TRUSSES

This section covers through trusses and half-through trusses, but not Bailey bridges.

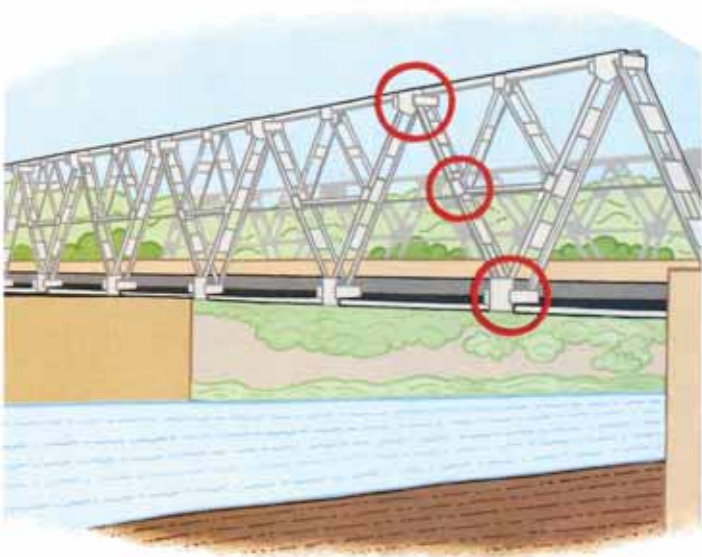

CHECK for deterioration of paint or galvanising. Look carefully at all places like the ones circled on the picture above.

* * *

CHECK for corrosion, especially at the joints in the truss. The bottom boom joints often corrode first. If there are signs of corrosion, especially near joints, check that plates are not laminated (see page [1] - 58).

Look for signs that corrosion is forcing the plates apart.

* * *

CHECK for bends in truss members. Make a sketch of the truss and mark any bent members on it. Using a straight edge or string line, measure the size of the bend and mark it on the sketch.

* * *

CHECK for bent or damaged joints. Make a sketch of the truss and mark any damaged joints on it.

* * *

CHECK for bent or damaged bracings. Measure the bend if possible and make a careful sketch of the pattern of the bracing system. Mark the damaged member on your sketch.

* * *

CHECK for loose bolts or rivets. Check all bolts or rivets in damaged or corroded joints. On the structure mark all loose bolts or rivets with paint. On a sketch of the truss, mark the joints with loose fixings.

If you find loose, damaged or missing bolts or rivets in a joint, look carefully along the line of the truss to see if the top has bent. If you see that it has bent, measure the bend with a line as shown in the pictures on page [2] - 81 and write a note.

* * *

Cracking is very serious as it can lead to rapid collapse. The engineer will tell you which areas must be checked for each inspection.

CHECK for cracking of the steel, particularly at welds and holes. If you find cracking, write a note or sketch to show where the crack is.

* * *

TIMBER BEAMS

This section covers log bridges, bridges made of sawn timber beams, like the one below, and bridges made of laminated timber beams.

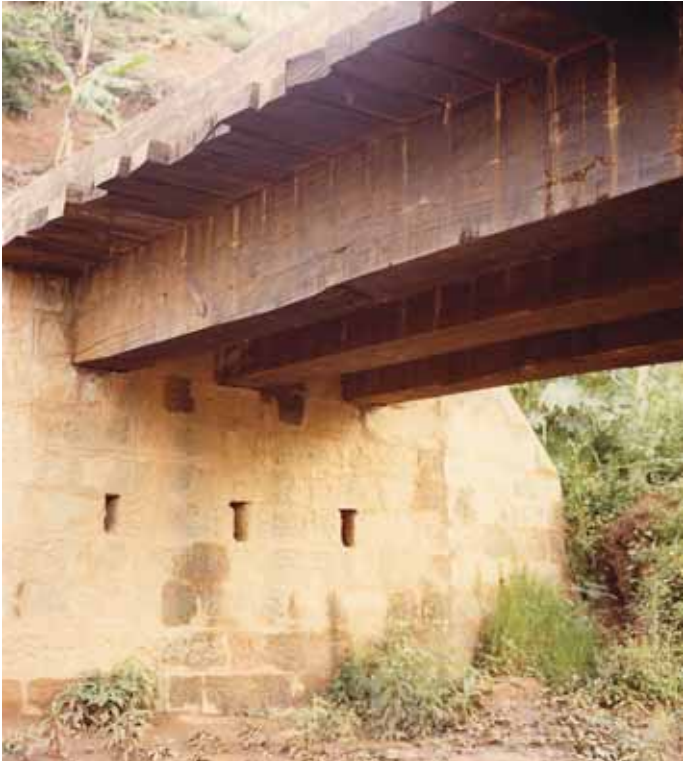

Log bridges are often poorly maintained and have a short life. But log bridges can last a long time if they are properly constructed and well maintained.

CHECK all timber for decay. Look very carefully at damp areas and around nails or spikes.

If the bridge beams (or logs) sit on the soil, or if the beams ends come into contact with the soil, then the ends often decay. Check this area carefully.

Look very carefully at logs with bark still in place, and when possible remove the bark.

* * *

CHECK all timbers for insect attack. If insect attack or decay is found, find out how much of the timber is affected. The notes on page [1] - 77 tell you about three tests using a spike, a hammer or a drill. Using one or more of these tests, keep checking until you find good timber. Make a sketch of the beam or log showing the decay or insect attack. Note on the sketch the size of the bad area and the depth.

* * *

CHECK for splitting of timber. There are 2 kinds of split which are important. Make a note if you find either of these:

1. Very large splits which may be getting bigger.
2. A split which will allow water to get into the beam or log and not drain out.

Splits on the top, or on the upper part of the sides, of a beam or log, are a problem. Splits on the bottom of a beam, or on a vertical member will drain and are not a problem.

* * *

Sometimes beams are made by sticking together smaller pieces of timber. These are called glue laminated beams. If the glue fails, the laminations (the small pieces which make up the beam) may separate. This could be serious.

CHECK for separation of the laminations of glue laminated beams.

On beam bridges, the main beams are often connected by timber cross beams which are nailed or spiked to the main beams. The nails or spikes should be tight.

On long span log bridges, sometimes many logs are needed. These are often held together by wire ropes. Check that the ropes are not corroded and are tightly fastened.

CHECK for loose or corroded nails, spikes or fixing wires.

* * *

TIMBER TRUSSES

Deck type truss bridges like this one have many small corners where dirt and debris collect:



CHECK for decay all over each truss. Look very carefully at joints and other areas where dirt or vegetation can collect.

The pin or bolt holes in the timber at joints already make those parts the weakest places on the timber. So when you use the spike and drill tests for decay do not make too many holes at joints because this will weaken the timber.

* * *

CHECK for insect attack.

* * *

CHECK for splitting of timber.

Some splits can be serious. There are 2 kinds of split you must report:

- large splits at joints which are close to bolt or pin holes. If you find these, make a sketch of the split, show the length of the split and the distance to any holes. This will help the next inspector to see if there is a problem. If the last inspector noted a split near a joint, check to see if it has got worse;
- splits where the wood is wet, causing decay inside the wood.

* * *

CHECK to see if the deck to truss connection is loose.

This is very important on bridges with nail laminated decks.

* * *

CHECK for loose or corroded bolts or pins at the truss joints. As timber dries, it shrinks. This can cause bolts in joints to be loose. Bolts can also loosen because of vibration.

* * *

CHECK for bends in truss members. Make a sketch of the truss and mark any bent members on it. Measure the size of the bend and mark it on the sketch. On bridges with the trusses above the road, look along the line of the truss to see if the top has bent. Measure the bend and make a note.

Small bends can be measured in the way shown on pages [1] - 60 and [1] – 61. Long bends in a truss are measured in the way shown on page [2] - 81.

* * *

CHECK for damaged or corroded steel parts (joint plates, bearing plates, etc.), and mark their location on a sketch.

* * * * *

UNDERSIDE OF DECK

CONCRETE

CHECK for cracking of concrete. Make sketches of any cracks wider than 1 mm, or cracks over a wide area. Mark and date the ends of important cracks, note any white deposits, and check if cracks have got any bigger since the last inspection.

* * *

CHECK for spalling of concrete.

* * *

CHECK for corrosion of reinforcement. Note any rust staining. Where concrete has spalled, note the cover and how much of the original bar has been lost by corrosion. Make a sketch to show where you have found signs of corrosion of reinforcement. Mark on it the size of areas of spalling, the pattern of cracking or the pattern of rust staining.

* * *

CHECK for poor concrete. Make a sketch showing the location and size of honeycombed areas and areas which are damp.

* * *

CHECK for not enough cover to reinforcement. If the cover is very small, you can see the pattern of reinforcement on the surface of the concrete.

* * *

STEEL

This section is for the underside of stiffened steel decks, for steel arch decks (buckle plates) and for trough decks.

CHECK for deterioration of paint or galvanising.

* * *

CHECK for corrosion of steel. Look everywhere, but check any wet areas especially. Look carefully at the bottom of troughs and the edge of steel arch decks. If you find laminations or other bad corrosion you must write a note on the form.

* * *

CHECK for bends in stringers or plates. On steel decked bridges if you notice a bend in the surface, look very carefully at the underside of the deck, below the bend. The stringers which carry the deck may have bent. This is serious.

On steel arch decks bends in the plate of the arches are very serious.

* * *

CHECK for loose bolts or rivets.

* * *

CHECK for cracking of the steel, especially at welds and holes.

* * *

TIMBER

This section is for the underside of timber decking on any type of main beams.



On log bridges, when the logs are close together it is not possible to inspect the underside of the deck timber. You can only check on the top surface of the bridge and the ends of the deck timbers.

CHECK for decay, look especially at any areas where water from the deck flows onto the timber.

Remember to seal and plug any drill holes you make.

If the timber deck is on a steel bridge look at the places where the timber sits on the steel beams. Also look for decay where the bolts or spikes enter the timber.

* * *

CHECK for insect attack.

* * *

CHECK for split timbers. When you inspected the top surface you will have seen any splits which go through the deck timbers.

Splits across the grain of the wood, which can be seen on the underside but not on the top surface, can happen when the timber is starting to break, possibly because of a heavy vehicle. If this has happened, make a note in your report that the timber must be replaced.

* * *

CHECK for loose or badly corroded bolts or pins.

* * *

MASONRY JACK ARCH DECKS

CHECK for change of shape of the arch. This can happen because of an overload or a failure in the material of the arch. If the change of shape is serious, the arch must be rebuilt.

* * *

CHECK for cracking or spalling of the bricks or masonry.

* * *

CHECK for poor pointing of the arches. If the mortar between the bricks or stones is in poor condition the arches might need repointing.

* * * * *

BEARINGS

This section covers all types of bridge except Bailey bridges.

Sometimes you will not be able to see all the parts of a bearing. If you cannot check all of a bearing, tick the 'ALL CHECKED - NO' box and do not tick the 'YES' or 'NO' box next to the questions you cannot answer.

First find out which bearings are fixed, and which are free. The bridge record card will give you the location of the fixed and free bearings. If you have difficulty, look back at pages [1] -21 to [1] -23.

Bearing shelves are very often wet places in which debris and vegetation collect.

CHECK for debris or vegetation around the bearings and on the bearing shelf. Remember, even small amounts of debris on the bearing shelf may cause damage to the bearing, especially if the drainage to the bearing shelf is not working properly.

* * *

CHECK for poor drainage to the bearing shelf. Look for signs that water stays on the shelf in wet weather.

* * *

CHECK to see if there is not enough room for the bridge span to move when the temperature changes. This is not easy. Tick 'YES' or 'NO' only if you are sure.

* * *

CHECK to see if the bearings are not seated properly on the abutment.

* * *

CHECK to see if the bridge span is not seated properly on the bearings.

* * *

CHECK for damaged bedding mortar. Look for cracks around the edges, and look for pieces of mortar which are broken off or crushed. You will need to clean all the soil and plants away from the bearing to see this.

* * *

RUBBER BEARINGS

Some rubber bearings have steel plates inside. If you can see the steel inside the rubber, the fault is bad.

CHECK for splitting, tearing or cracking of the rubber.

* * *

Fixed bearings usually have a pin or bolt fixing the beam to the support through the bearing. On concrete bridges, it is not possible to see the pins used in the fixed bearings. They cannot, therefore, be checked. On steel girder bridges the heads of the bolts or pins can usually be inspected.

CHECK for damaged or loose bolts or pins at fixed bearings on steel beam bridges.

* * *

METAL BEARINGS

Look carefully at the bearing and decide which type of metal bearing you are inspecting.

This is a typical simple metal sliding bearing. Note the corrosion caused by debris on the bearing shelf:



* * *

CHECK if any of the bearing parts are not properly seated.

* * *

If pieces of gravel or other debris are caught in the moving parts of a bearing, they can damage it or stop it moving.

CHECK if any moving parts are not free to move. Look to see if anything is caught in the bearing. Look at the surface where the bearing should move. You can usually see a narrow clean area where the bearing moves. There will be a thin line of dirt at the edge of the area the bearing moves over.

* * *

Some rocker or roller type bearings, and bearings where steel slides on bronze, have LUBRICATION SYSTEMS.

CHECK for problems with the lubrication system. If there is a lubrication system and you find a fault with it, write a note on the form.

* * *

For a sliding bearing to work, the sliding surfaces must be in good condition.

CHECK to see if the sliding surfaces are damaged. Look very carefully at the sliding surfaces. A small amount of corrosion on a sliding surface will cause large forces. The bridge could then be damaged. Look carefully at the PTFE but be careful. It is easily damaged.

* * *

CHECK for cracks or bends in metal parts.

* * *

CHECK for corrosion of metal parts.

* * *

EARTHQUAKE RESTRAINTS

On modern bridges in earthquake areas, there may be an earthquake restraint. An earthquake restraint stops the span from falling off the abutment or pier during an earthquake.

There are many types of earthquake restraint. Here are four common types:

1. A large bolt or bolts which hold the span down.
2. Extra strong wing walls which stop the span falling off.
3. A block of concrete between the bridge girders.
4. Special frames of steel or concrete, at the end of the bridge, which stop it falling off in an earthquake.

CHECK for damaged or loose earthquake restraints.

* * * * *

MASONRY ARCHES

CHECK for change of shape of the arch. You must:

1. Stand a long way from the arch. Compare the shape of the arch left of centre, with the shape of the arch right of centre. Any difference means the arch has changed shape.
2. Look at the centre stone on the face of the arch. If this has moved out of line, the arch will be badly weakened.
3. Go underneath the arch and check the barrel of the arch. Look to see if parts of the barrel have changed shape differently from the face of the arch. (This often happens).
4. Look at the other face to see if the arch has changed its shape or if the centre stone has moved.

Mark the location of any change of shape on a sketch or on the overall plan on page 1 of the report form. Estimate the amount of change of shape, if possible, and write it on your report.

In this picture there is a crack in the spandrel wall and the arch has changed shape:

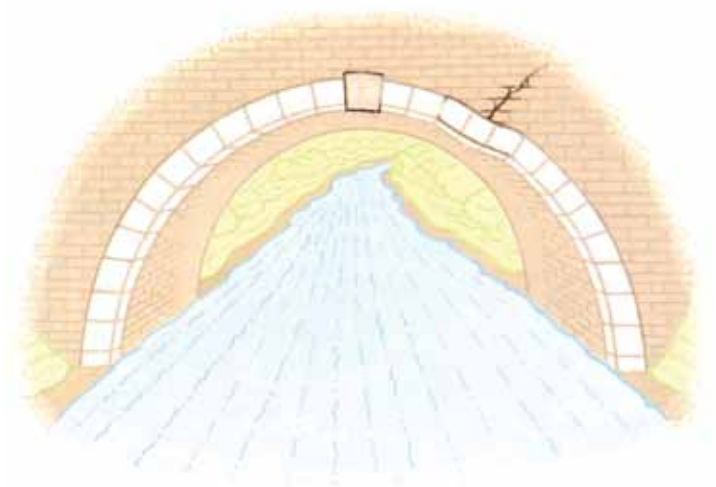

* * *

CHECK for cracking of the arch barrel. On the plan on page 1 of the report form, sketch any long cracks which run through the arch.

* * *

If you find vehicle damage to the parapets, check that the spandrel walls under the parapet have not been pushed out or cracked by the impact.

Where a road crosses an arch bridge there is sometimes a hump. When heavy vehicles hit this, they can push the spandrel walls outwards.

Two things can happen:

1. The spandrel wall can crack and bulge.
2. The spandrel wall separates from the arch and is pushed outwards. If this happens, you can see a step in the masonry between the arch barrel and the spandrel wall.

CHECK for cracking or bulging of the spandrel walls. If you see a crack or bulge make a sketch of each face of the arch and spandrel walls. Mark any cracks or bulges on your sketch.

* * *

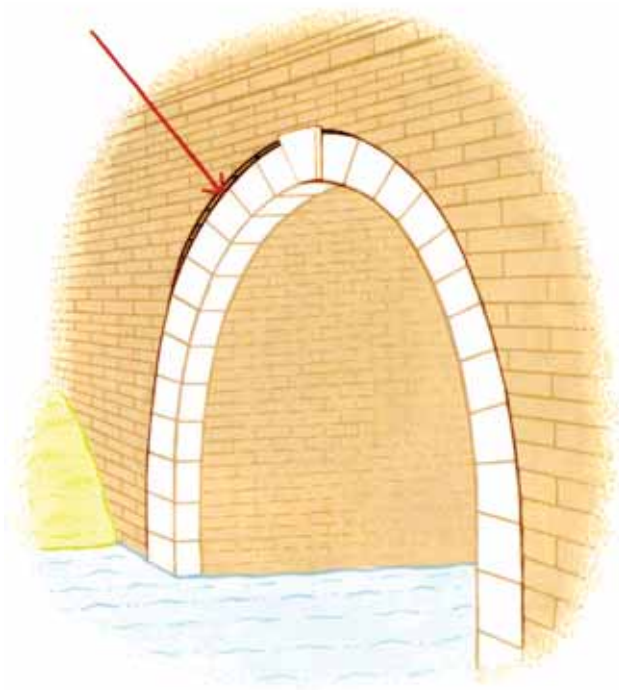

CHECK to see if the spandrel wall has separated from the arch, as in the picture above.

* * *

CHECK for spalling of the stones or bricks of the arch and spandrel walls.

* * *

CHECK for poor pointing.

* * *



The materials of an arch will gradually deteriorate with the effects of water and weather. Most arches leak some water through them. A small amount of water is not a problem but if the leak is bad then the bridge will be damaged. If a lot of water is leaking through the arch, you will see white stains near the joints and sometimes clear, wet areas, where the water has been running.

CHECK for water leaking through the arch.

* * *

All masonry arch bridges have spread foundations. If an arch foundation settles, the bridge will be badly damaged. Scour can cause settlement.

CHECK for scour under the arch foundation. Use a long pole to feel if there is scour. If you can push the pole into the ground under the arch foundation there is a bad problem.

* * * * *

BAILEY BRIDGES



Many different kinds of bridge have been made using the basic Bailey panels. Design details have changed over the years, and different strengths of steel have been used.

It is not possible to describe all the variations of a Bailey bridge in this chapter, so you will need help from the engineer, until you get to know the bridges in your area.

There are no extra parts on a Bailey bridge, **All the parts are needed**. If some parts are removed, the bridge may still look safe, but it could fall when a heavy vehicle crosses it. You need to check very carefully to make sure no parts are missing.

The drawing below shows most of the parts of a typical Bailey bridge and gives their names. Not all Bailey bridges are exactly like this.

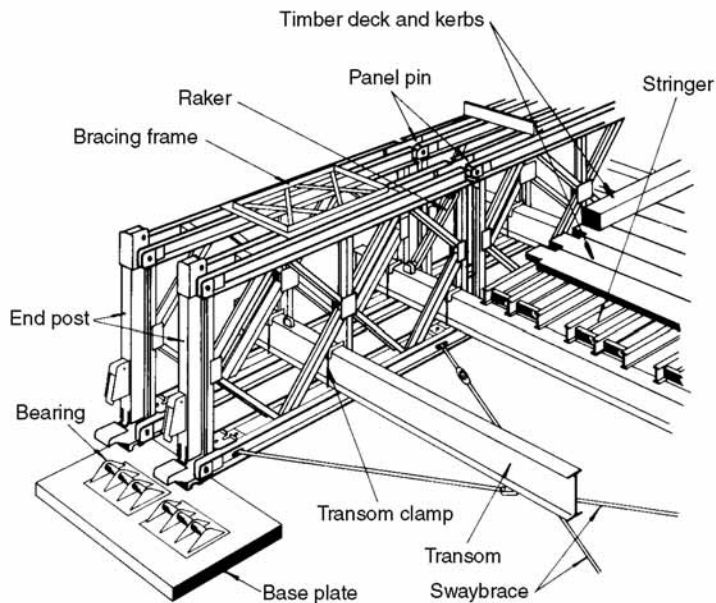

This drawing reproduced by permission of Mabey Johnson Ltd, Twyford, Berks, UK

On single span Bailey bridges, panel pins usually stay in place. On continuous bridges (two or more spans), when the bridge moves under traffic, panel pins can be moved. The panel pins can even work loose and fall out if the SAFETY PIN is missing. This is most likely to happen about one quarter of the span away from a pier.

CHECK for missing safety pins.

* * *

CHECK for missing panel pins.

* * *

CHECK for missing or loose bolts. The bolts that hold on the CHORD reinforcement and hold together DOUBLE STOREY BRIDGES are very important.

* * *

CHECK for missing rakers and tie plates. Some bridges use vertical bracing frames in place of rakers.

* * *

CHECK for missing or loose sway braces. Check that the pins are in place and that the lock nuts are screwed up.

* * *

Some Bailey bridges have horizontal bracing frames on the top chords of the panels.

CHECK for missing, loose or damaged horizontal bracing frames.

* * *

CHECK for missing or loose transom clamps. Some modern Bailey bridges do not use transom clamps. For these, note on the inspection form - 'no transom clamps'.

* * *

Bailey bridges move a lot when vehicles cross them. This causes wear, where the stringers sit on the transoms.

CHECK for wear at the stringer to transom SEATING.

* * *

The original Bailey bridge panels sometimes cracked and some bridges fell down because of this. Modern Bailey bridges are less likely to crack, but unless you are told not to, you should:

CHECK ALL Bailey bridges for cracking.

This picture shows where you should look for cracks:

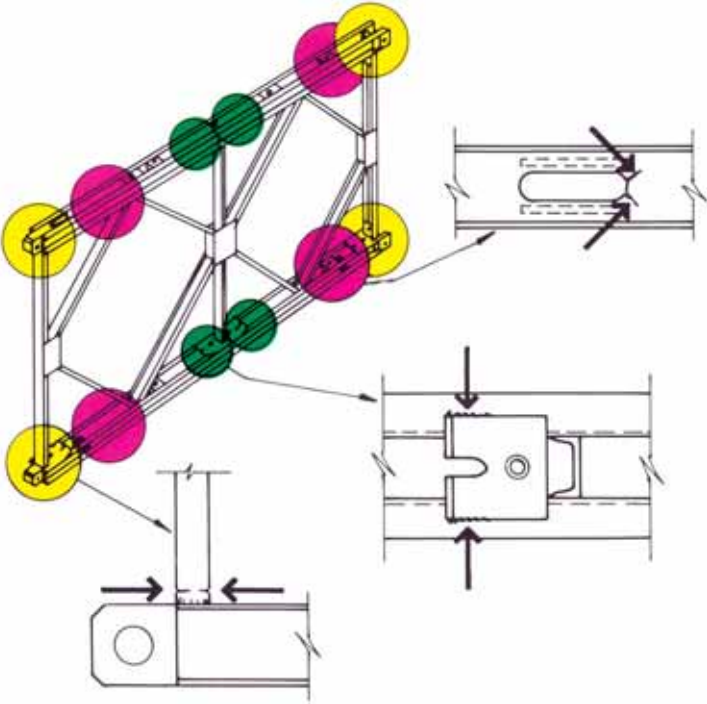

All these places must be checked on *each* panel at *each* inspection.

* * *

Parts of the bridge can get bent.

CHECK for bends in bridge members. Note where the damage is and sketch the damage.

* * *

CHECK for deterioration of paint or galvanising.

* * *

CHECK for corrosion. There are some areas on a Bailey bridge where dirt and moisture collect. Look especially at:

1. The bearings.
2. The base of the rakers.
3. The bottom chord near the SPACER PLATES and where the diagonal members (diamonds) join.
4. The panels and transoms near where the transom sits on the bottom chord.

Bailey bridges are made of lots of panels, so it is not easy to make a sketch showing where you have found a problem. If you find a panel that is damaged, or has any problem, mark it with paint and give it a number. When you fill in the report form you can write the number in the column for notes.

* * *

CHECK for settlement of the bearings.

* * *

CHECK for damage to the bearings and baseplates.

* * *

All Bailey bridges sag a little at the middle of the span, and some are bent sideways. Look at the photograph and the two drawings. They show you how to measure the vertical sag and the horizontal bend.

Look along the top of the panels on one side of the bridge. You will need an assistant to help measure the sag and the bend with a rule or measuring tape, taking instructions from you.

Write on the report form the biggest measurement of vertical sag and the biggest measurement of horizontal bend on the upstream side of the bridge. Then measure the sag and bend on the downstream side of the bridge and write these measurements on the report form.



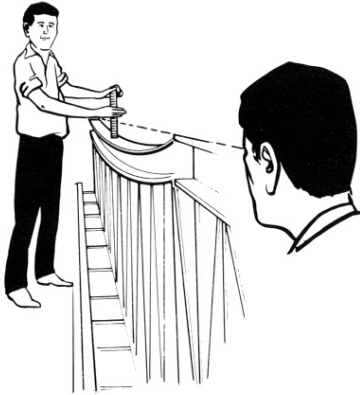

Measuring the vertical sag

Measuring the horizontal bend

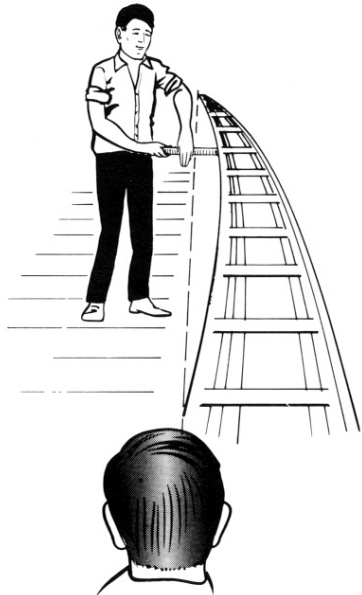

* * * * *

ABUTMENTS, WING WALLS AND RETAINING WALLS.

GENERAL

The most common major problem with abutments is scour caused by the river. If the river scours the foundations or the bank in front of the abutment, the abutment will move and the bridge may even fall. This photograph shows how a river can quickly scour under an abutment, causing it to move and displace the deck. Scour should be reported as soon as it starts, so that the damage can be repaired before it gets this bad.



Bank seat abutments can easily be damaged if the bank under them is scoured by the river or eroded by rain water, so you must look very carefully for scour or erosion near bank seat abutments.

The picture below shows scour under a piled abutment:



CHECK for erosion and scour near the base of the abutment, or scour of the bank in front of the abutment. If the water is not low enough or clear enough to see, then use a long pole to feel if the river has caused scour.

* * *

CHECK for damage to caissons, or damage or corrosion to piles, if you can see them.

* * *

CHECK for movement of the abutment. This can be a serious problem.

Look for disturbance of the ground around the abutment. If the abutment has moved, there are often cracks in the soil. There may even be cracks in the road behind the abutment.

* * *

In a flood, debris against the abutment can cause damage to the abutment or the bridge superstructure. Debris can also cause the river to scour the soil around the abutment.

CHECK that there is no debris on, or against, the abutment.

* * *

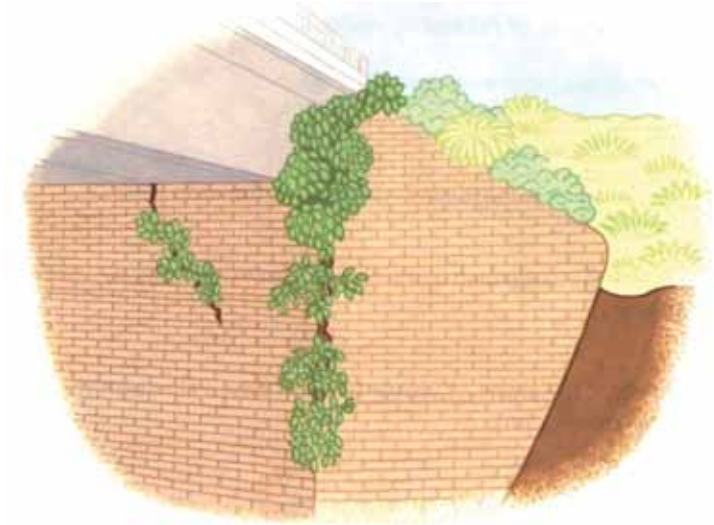

CHECK for vegetation growing on or in the abutment.

Look in cracks or drains in the abutments, or in cracks between the abutment and wing walls or retaining walls.

* * *

CHECK for scour near to retaining walls.

* * *

CHECK for signs of movement (sliding forward or settlement) of retaining walls.

Look at the picture on page [1] - 30.

Look for:

- a step where the retaining wall meets the wing walls or abutment;
- damage to the road or the embankment supported by walls.

* * *

CHECK for signs of water leaking down through the expansion joint.

* * *

DRAINAGE SYSTEM

Look at the abutment and the retaining walls. Look for signs that the drainage system is not working properly.

CHECK to see if there are not enough weep-holes. As a general guide, weep-holes should be less than 2 metres apart, measured both horizontally and vertically. If the water coming out of the weep-holes washes away the soil in front of the abutment then there are not enough weep-holes.

* * *

CHECK to see if the weep-holes are not working. In wet weather, check that the bottom weep-holes have carried water recently.

In dry weather, look carefully to find out if the weep-holes carried water when it was raining.

Look for signs such as:

- if there are insect nests in the weep-holes, then the weep-holes may not be working.
- if there are water stains below the weep-holes, then the weep-holes are probably working.

* * *

Water may find other ways through the abutment if the drainage system is blocked.

CHECK for water leaking through the abutment. Look for dampness or white staining at cracks or construction joints.

* * *

CONCRETE ABUTMENTS, WING WALLS AND RETAINING WALLS

CHECK for cracking of the concrete. Make a sketch showing where important cracks are. Show only those cracks which are wider than 1 mm or those where water has come through.

Look carefully for cracks:

- in pilecaps;
- where wing walls connect to the abutment;
- around parapet posts;
- near bearings even thin cracks can be important, so draw all cracks near bearings.

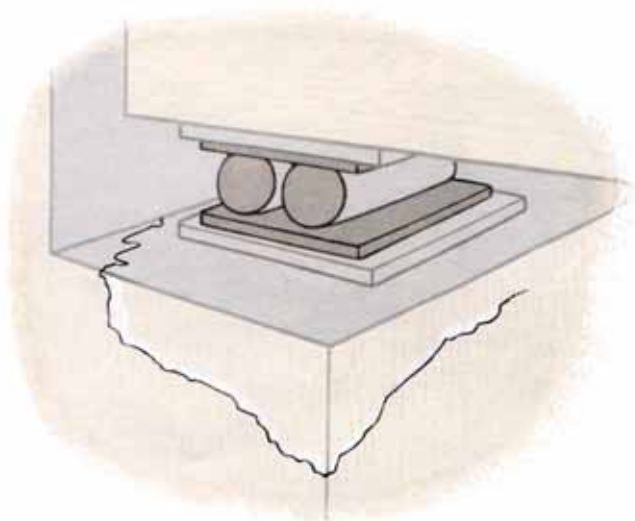

* * *

CHECK for spalling of the concrete. Mark spalled areas on a sketch.

* * *

CHECK for corrosion of reinforcement. Look for rust stains from cracks and look where concrete has spalled. Where concrete has spalled, measure the concrete cover to reinforcement, and measure how much of the bar has been lost.

* * *

CHECK for poor quality concrete. Look for honeycombing and chemical attack.

* * *

MASONRY ABUTMENTS AND RETAINING WALLS



CHECK for cracking of the masonry. Sketch all cracks wider than 3 mm at the widest place and where there is a step across the crack.

At abutments, look carefully for any cracks which **run underneath the bearing**. If you find a crack which goes all round the bearing seating, make a note of it. This is very serious as the bridge may fall down.

* * *

Bulges in abutments are more serious than bulges in retaining walls. Any bulge, especially if there are horizontal cracks near it, can be serious.

CHECK for bulging of the abutment or retaining walls. Make a sketch showing the area which is bulging. If you can, put a straight edge against the bulging part and measure how much it has moved out of line.

* * *

CHECK for poor pointing of the masonry.

* * *

CHECK for deterioration of the bricks or stones.

* * *

GABION ABUTMENTS AND RETAINING WALLS

Gabions are often used as retaining walls and as abutments for simple bridges. For example, they are sometimes used as abutments for timber bridges, Bailey bridges and steel beam bridges with timber decks.



When gabion abutments settle or bulge, the bridge deck may be damaged, or the road may be damaged.

CHECK for settlement or bulging of the gabions.

- For abutments, look for any change which allows the bridge to settle. Make a note of the amount of settlement.
- For retaining walls look for any change of shape which allows cracks or hollows to form in the road.

* * *

The gabion wires and the tie wires can be torn by debris carried by the river, or by large changes in shape of the baskets. They may corrode.

CHECK for damage to the gabion wires or ties.

TIMBER ABUTMENTS AND RETAINING WALLS



Abutments made of logs tied or spiked together are often used for log bridges. Retaining walls are sometimes made in the same way.

Abutments for timber bridges are also sometimes made using timber piles and a timber cross beam.

Because the timber is in contact with the ground, it will decay. Insect attack is also very common.

CHECK for decay. Look near the beams of the span. In timber piles, look near the ground or at water level.

* * *

CHECK for insect attack. Look where the beams sit on the abutment.

* * *

CHECK for splitting of timber.

* * *

CHECK for loose or corroded binding cables.

* * *

CHECK for loose or corroded fixing spikes.

* * * * *

EMBANKMENTS AND FILL IN FRONT OF ABUTMENTS

GENERAL

If the base of the embankment is being washed away by the river, the slope will become unstable.

CHECK for scour at the base of slopes.

* * *



Where scour happens, the embankment fill may slip down, as in the photograph above.

CHECK for slip of embankment fill.

* * *

If rainwater on the approaches to the bridge is not properly drained, water may run down the face of the embankment. After some time it might wash the fill away. This can damage parts of the abutment or wing walls.

CHECK for erosion of the fill near the abutment.

* * *

Cracking of the road, or embankment edge, behind a retaining wall, might be a sign that the wall has moved.

CHECK for cracking of the road or embankment edge.

* * *

If there is a hole deep in the embankment behind the abutment then, as soil drops into the hole, a small circular hole, called a 'pipe' will appear at the road surface, or in the embankment edge, as in the photograph below. This is called a 'piping failure' and shows that material is being lost from around the abutment.

CHECK for piping failures of the fill behind the abutment.



* * *

PILED WALLS

Piled walls are used at the bottom of embankments to prevent the river scouring away the fill around the abutment. Piled walls can be made of steel (usually sheet piles), or timber (usually logs), and sometimes concrete.

CHECK for forward movement of the piles caused by river scour. If large sections of the wall have moved forward, the problem is serious. Small movements are not serious.

* * *

CHECK for deterioration of the piles:

Steel piles: look for corrosion.

Timber piles: look for decay.

Steel and
timber piles: look for damage caused by debris.

Concrete: look for cracking and exposed reinforcement.

* * *

STONE PITCHING SLOPE POTECTION

Stone pitching is one way of protecting the surface of a slope from being washed away by rain, or by water running off the road.

If the embankment settles, the stone pitching may crack. Small cracks are not serious.

CHECK for cracking of the stone pitching.

Make a sketch of any cracks wider than 5 mm. The next inspector can check if the crack is getting wider or longer.

If the mortar pointing is poor, then the stone pitching will break up.

CHECK for poor pointing.

* * *

The bank behind the stone pitching may be scoured by the river, or eroded by water running down the slope.

CHECK for scour or erosion at the edges of the stone pitching.

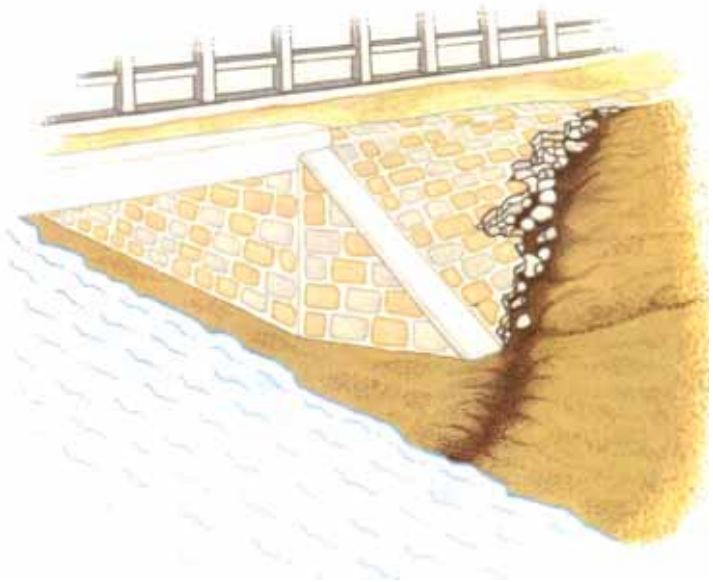

If the stone pitching has been badly undermined, pieces may break off.

CHECK for pieces broken off the stone pitching.

* * *

GABION SLOPE PROTECTION

Gabions or reno mattresses are often used to protect slopes from being washed away by rain water running off the road, or by the river.

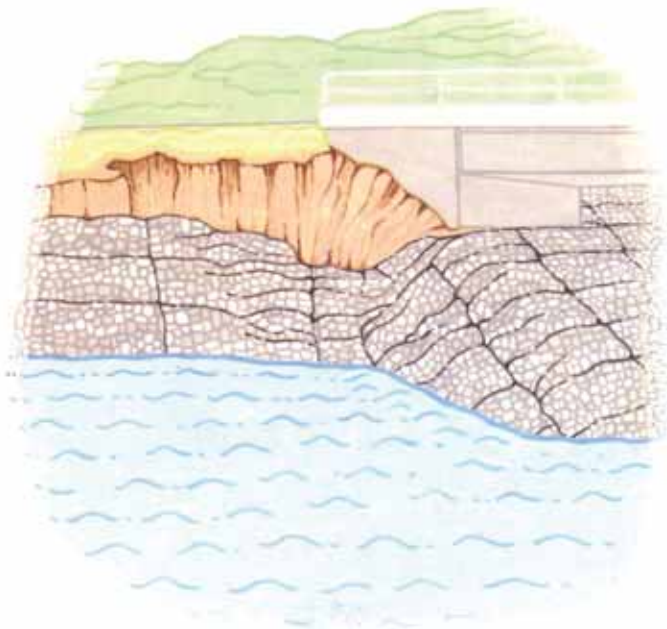

Gabions can move a lot without being damaged, but the slope protection must still be complete.

The picture above shows too much movement of the gabions.

CHECK for too much movement of gabions.

Make a note it:

- the slope protection has settled so far that the top of the slope is not protected (the road edge may have cracked);
- there is bad scour at the bottom of the slope.

* * *

The wires which make up the gabion boxes and the wires which tie the boxes together must be in good condition.

CHECK for damage to the gabion wires and ties.

* * *

RIP-RAP SLOPE PROTECTION

For rip-rap to work, the rocks must be too heavy for the river to move them.

CHECK if the rip-rap is being washed away.

* * *

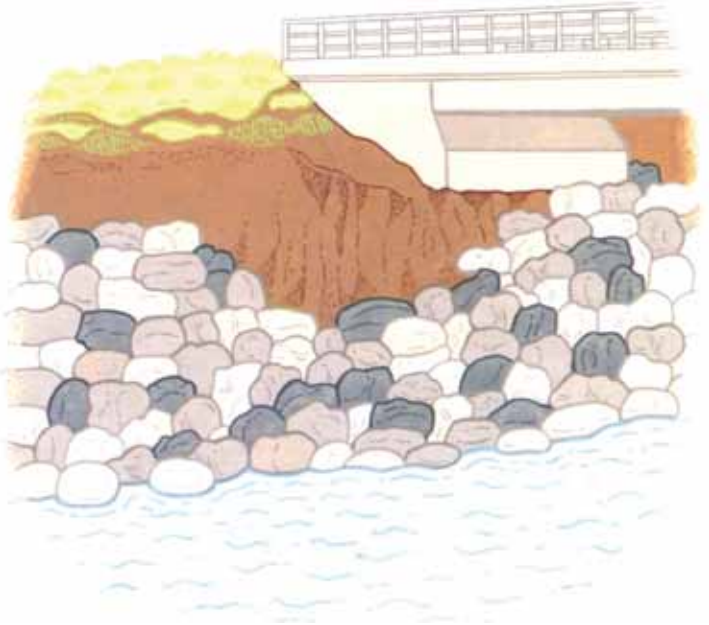

As the river scours the embankment the rip-rap will sink into the river bed.

CHECK for bad settlement of the rip-rap.

* * * * *

BED PROTECTION

It is important that the river bed under a bridge is not damaged by the river.

CHECK for large holes in the river bed under or near the bridge.

* * *

If the river flows fast and the river bed is soft, the bed may be protected with:

- stone pitching;
- concrete;
- gabions;
- rip-rap.

STONE PITCHING OR CONCRETE BED PROTECTION AND APRONS

The river often scours the river bed away at the edge of the bed protection. Small scour holes are not important. If a hole goes under the bed protection, you should report it.

CHECK for scour at the edge of the bed protection. Make a note of where the scour is and draw a sketch.

* * *

Cracks in the surface of bed protection are usually because of settlement.

CHECK for cracking. For mass concrete and stone pitching, only report large cracks. For reinforced concrete, report all cracks.

To find cracks, first use a spade to scrape off any sand or debris. Then look carefully for any cracks. If you find cracks, draw a sketch of them.

* * *

CHECK for any signs of spalling of concrete or stones missing from stone pitching.

* * *

Stone carried by the river often cause erosion of the surface of the concrete.

CHECK for erosion of the surface of the concrete or stone pitching.

* * *

For reinforced concrete bed protection, if there is spalling or erosion, the reinforcement may be corroding.

CHECK for corrosion of reinforcement.

* * *

GABION BED PROTECTION AND APRONS

Gabions or reno mattresses used as river bed protection have a very big advantage. They are flexible, so that when scour takes place, the edge of the gabion drops down to fill the hole.

Because of this, scour is not usually a problem when the gabions are in good condition.

CHECK for signs that the gabions have broken away from the pier or abutment. If this happens the river could destroy the bed protection very quickly.

* * *

CHECK for damage to gabion wires or ties. Look carefully for broken wires or corrosion of the wires.

* * *

RIP-RAP BED PROTECTION AND APRONS

Rip-rap is often used to prevent scour damage to piers. It is sometimes necessary to put down more rip-rap to replace rip-rap lost during floods, or which has settled into the river bed.

CHECK for loss of rip-rap. If you think that some rip-rap has been lost, make a sketch of the rip-rap you can see.

Is this less than at the last inspection? If so, more rip-rap might be needed.

* * * * *

PIERS

GENERAL

Different kinds of piers are shown in this handbook on pages [1] - 18 and [1] - 19. For each bridge inspection, you will see what kind of pier you are to inspect by looking at the Construction Details on page 2 of the report form.

To inspect the piers on some bridges you will have to use a boat.



CHECK for scour near the base of the pier. If the water is not low enough or clear enough to see, then use a long pole to feel if the river has caused scour. If you can feel under the base of the pier then the scour is serious.

The photograph above shows bad scouring under piled piers.

* * *

If the caissons or piles are exposed they can be damaged, or the piles can corrode.

CHECK for damage to caissons or piles, or corrosion of piles.

* * *

A pier will move if its foundation fails due to scour, or due to overloading of the bridge. It may also move due to impact from a boat or due to an earthquake. Movement of the pier can cause:

- one expansion joint to close and the other expansion joint to open;
- damage to a continuous superstructure.

CHECK for movement of the pier. To do this:

- look along the line of the piers, if there are other piers, to see if one is out of line;
- look along the top of the bridge to see if the bridge is a smooth line. If there is a hollow at a pier then the pier has settled;
- look carefully at the expansion joints and bearings.

* * *

Boats or floating logs can damage river piers. Vehicles can damage the piers of bridges over roads.

CHECK for impact damage due to boats, floating logs, or vehicles.

* * *

Debris can damage river piers.



CHECK for debris against the pier. Light branches are not a problem unless there are a lot of them.

* * *

CHECK for vegetation growing on the pier.

* * *

There may be an expansion joint in the bridge deck above a pier. If water leaks down past the expansion joint in the bridge deck and gathers near the bearing, it can do a lot of damage to the bridge. You will only be able to see if water is leaking through the expansion joint when you are under the bridge.

CHECK for water leaking past the expansion joints.

* * *

CONCRETE PIERS

CHECK for cracking of the concrete. Make a sketch showing where important cracks are.

Look carefully for cracks:

- around bearings;
- in pilecaps;
- in beams over columns.

* * *

CHECK for spalling of the concrete. Mark spalled areas on a sketch.

* * *

CHECK for corrosion of reinforcement. Look for rust stains from cracks and look where concrete has spalled. Where concrete has spalled measure the concrete cover to reinforcement, and measure how much of the bar has been lost.

* * *

CHECK for poor concrete. Look for honeycombing and chemical attack.

* * *

MASONRY PIERS

Cracks in masonry piers are sometimes caused by failure of the foundation. These cracks are usually long and go deep into the pier. Cracks around bearings may be caused by traffic loads or by the 'free' bearing not being able to move.

A dangerous crack under a bearing is shown on page [1] - 69.

CHECK for cracking of the masonry. Note especially any long and wide cracks, and any cracks near bearings. If you find a crack which goes all round a bearing, write a note on the report form. This is very serious as the bridge may fall down.

* * *



Brickwork and masonry in a pier can lose some of its mortar pointing because of the flow of the river. Later, bricks or stones may be washed out. This can be serious, as the pier is then not so strong.

CHECK for poor pointing.

* * *



The flow of water past a pier and the constant wetting and drying can, over a long period of time, damage the material of the pier.

CHECK for deterioration of bricks or masonry.

Test the surface by hitting it (not too hard) with a hammer. If pieces of the surface fall off, the bricks or stones are in poor condition.

* * *

STEEL PIERS

Floating vegetation, such as branches and grasses, can catch on the steelwork and collect in the joints. This keeps the joints wet and makes them corrode.

CHECK for debris in the joints of the steelwork.

* * *

CHECK for deterioration of the paint or galvanising.

* * *

CHECK for corrosion, especially near the water level. If the pier is in salt water, look especially at the part of the pier between high tide and low tide.

* * *

Steel piers may be damaged by boats, or logs carried by the river in flood. If debris collects, then the river can push the pier very hard.

CHECK for bends in steel members or joints.

* * *

CHECK for loose bolts or rivets.

* * *

CHECK for cracking. Look carefully near the bearings for loose bolts or cracks in the steel.

* * *

TIMBER PIERS

Floating vegetation and debris, can catch on the timber and collect at the joints. This keeps the joints wet and makes the timber decay.

CHECK for debris in the joints.

* * *

CHECK for decay. Look carefully at the joints. Look carefully near the water when the pier is in fresh water.

* * *

CHECK for insect attack. Look carefully below the water level when the pier is in salt water. Attack by teredo worms is very common here.

* * *

CHECK for splitting of the timber. Note large splits, splits near bolt holes, and any splits where water can sit and cause decay.

* * *

CHECK for loose bolts or pins at joints.

* * *

The timbers of the pier may be bent if the pier is hit by a log or boat. They may also bend if the bridge is overloaded.

CHECK for bends in timbers.

* * *

Most timber piers have some parts made of steel, such as plates at the joints. Often these steel joint plates and fixings corrode at river level.

CHECK for damaged or corroded steel parts.

Look for:

- Deterioration of paint or galvanising.
- Corrosion.
- Bends.
- Cracking, especially near welds.

* * * * *

CULVERTS

GENERAL

Because culverts are small, they are often blocked by debris or vegetation. In desert areas, culverts can be blocked by sand:



CHECK for debris, vegetation, etc, in or near the culvert.

* * *

Sometimes, when a culvert is built, the ground is not properly compacted. If the ground is not properly compacted, parts of the culvert may settle. When this happens the water may not flow properly through the culvert, or there may be a dip in the road above.

CHECK for settlement of parts of the culvert.

* * *

Flood water can scour the ends of the culvert, or the edge of the apron, or the road embankment.

CHECK for scour at the ends of the culvert, or at the edge of the apron. Mark where there is scour damage on a sketch of the culvert.



* * *

On very small culverts, like the one shown on page [1] - 84, the last three checks are all that you can do.

The following checks are for larger culverts and culverts with wing walls and aprons.

CONCRETE CULVERT BARRELS

If you need them, there are notes on inspecting reinforced concrete on pages [1] - 43 to [1] - 55.

CHECK for cracking.

* * *

CHECK for spalling.

* * *

CHECK for corrosion of reinforcement.

* * *

CHECK for poor concrete. Make a sketch to show any cracking, spalling, corrosion or poor concrete.

* * *

CORRUGATED STEEL CULVERTS

Corrugated steel culverts can be different shapes. Mostly they are circular, oval or arched.

A culvert can change shape because it was badly constructed, or because the traffic above it is too heavy. If a corrugated steel culvert changes shape it can collapse. Even a small change in shape of a culvert can make it collapse.

CHECK for change of shape of the culvert barrel.

* * *

Corrosion can be a problem with corrugated steel culverts. Most culverts are galvanised, but some are protected by paint. Stones and other debris can damage the galvanising and paint. If this happens, there will be corrosion.

CHECK for damage or deterioration to paint or galvanising.

* * *

CHECK for corrosion of steel. Corrosion can also begin on the outside of the culvert, which you cannot see. A common place to find corrosion is next to the bolts between sections of the culvert.

* * *

The bolted joints are very important to the strength of the culvert. All bolts must be tight and in good order.

CHECK for loose or corroded bolts.

* * *

CULVERT APRONS

Like bridges, culverts may be protected from scour by aprons. These aprons can be made of gabions or reno mattresses, concrete, or stone pitching.

Sometimes, scour causes the apron to settle at the edge. Concrete or stone pitching may crack and break up.

CHECK for cracking and damage to concrete or stone pitching.

* * *

Gabion or reno mattress wires or ties may corrode or be damaged by debris. The stones in the gabions may then be washed away and the gabion will not do its job. The gabion baskets can settle or move due to scour.

CHECK for damage to gabions.

* * *

HEADWALLS

Headwalls retain the embankment fill at the ends of the culvert. They can be made of concrete or masonry. If a headwall settles or is pushed forward, water can wash away the embankment fill at the joint between the headwall and the culvert barrel. This can damage the embankment.

CHECK for movement of the headwalls. Look carefully at the joint between the headwalls and the culvert barrel.

* * *

For Concrete Headwalls

CHECK for cracking, spalling, corrosion of the reinforcement, or poor concrete. Make a note of the kind of problem you find, and make a sketch to show where the problem is, and how big the problem is.

* * *

For Masonry Headwalls

CHECK for cracking, poor pointing or deterioration of the bricks or stones. Make a note of the kind of problem you find, and make a sketch to show where the problem is, and how big the problem is.

* * * * *

APPENDICES

- A. WORD LIST.
- B. EQUIPMENT LIST.
- C. SAFETY DURING INSPECTIONS.
- D. EXAMPLE OF A COMPLETED REPORT FORM.

APPENDIX A

WORD LIST

This is a list of engineering words that are used in this book, and their meanings.

The first time these words appear in the book, they are printed in CAPITAL LETTERS, so that you will know that they are explained here.

In some of these notes you are asked to look at a page where there is a picture or some more information that will be helpful.

The picture on page [2] - 76 shows most of the parts of a Bailey bridge. The Bailey bridge parts not shown in the picture are described in this word list.

ABUTMENT: end support of a bridge, see pages [1] - 6 and [1]-17.

APPROACH EMBANKMENTS: the earthwork that carries the road up to the bridge.

APPROACH ROAD: the road near the bridge.

APRON: bed protection at the mouth of a culvert, see page [2]-120.

ARCH: curved bridge structure, see page [1] - 12.

BAILEY BRIDGE: a type of steel truss bridge designed for quick assembly, see page [2] - 75.

BALLAST WALL: abutment wall above bearing shelf, see page [1]-17.

BANK SEAT ABUTMENT: an abutment set well up the river bank; above the usual river level, see pages [1] - 14 and [1] -15.

BARREL (of arch): the main part of an arch which supports fill and road, see page [1] - 12.

BARREL (of culvert): the pipe or box part of a culvert where water flows.

BEAM: narrow member which spans between supports; for example a log in a log bridge.

BEARING: this part is between the deck and the abutment or pier. It carries the weight of the deck, and slides or hinges to allow the deck to move. See pages [1] - 16, [1] - 20 and [1] - 21.

BEARING BOLT: type of fixing for joints in steel or timber, see page [1] - 65.

BEARING SHELF: part of the abutment, where the superstructure rests, see page [1] - 16.

BED (RIVER BED): the bottom of the river.

BED (AS IN 'BEDDED IN MORTAR'): fix in place with (mortar).

BOOM: top or bottom part of a truss, see page [1] - 1 0.

BOX GIRDER: a hollow beam with a box shape, see page [1]-7.

BRACING: parts of a bridge which help to keep it stiff and not change shape, see page [1] - 10.

BULGING: where a flat place changes shape and is bent.

CAISSONS: type of masonry or concrete foundations, built like a tube, see page [1] - 13.

CANTILEVER: a beam, fixed at one end and free to move at the other.

CHORD: On a Bailey bridge, a chord is a long steel plate bolted to the truss to make it stronger.

COMPRESSION (STRONG IN COMPRESSION): being pushed together, see page [1] - 44.

CONDENSATION: water from the air that settles on a cold surface.

CORRODE, CORRODED (STEEL): to be attacked by rust.

CORROSION: damage done to steel (or other metal) by air, water, salts, etc.

CORRUGATED STEEL: thin sheets of steel which have been shaped to make them strong.

COVER (COVER TO THE BAR): the thickness of the concrete over the reinforcement at that place.

CROSS GIRDERS: steel beams that connect two trusses.

CULVERT: a tube or box to carry water under a road, see pages [1]-83 and [1]-84.

DEBRIS: rubbish and other unwanted things.

DECAY: rotting of wood, making it soft and weak; caused by dampness and fungus.

DECK (DECKING): top of bridge superstructure, see page [1]-7.

DETERIORATE, DETERIORATED: to become worse; to get into a bad condition.

DOUBLE STOREY BRIDGE: bridge made of two trusses, one on top of the other, each side of the bridge.

DOWNSTREAM: where the river flows away from a bridge.

DRAINAGE: system for taking waste water (usually rain water) away.

EMBANKMENT: soil bank which supports the road, see pages [1] - 6 and [1] -17.

EROSION, ERODING: removal of earth by wind, rain or flowing water.

FILL (FILL IN FRONT OF THE ABUTMENT): soil placed in front of the abutment.

FIXED (FIXED BEARING): not able to move, see page [1] - 21.

FLANGE: the top or bottom of a girder, see page [2] - 47.

FOUNDATIONS: the lowest part of the bridge which sits on or in the ground.

FUNGUS: type of plant which grows on decayed timber.

GABION: wire basket filled with stones, see pages [1] - 81 and [2] - 102.

GALVANISING: a thin layer of zinc on steel to protect it against corrosion.

GIRDER: a beam, usually made of steel, see page [2] - 47.

GROYNE: a wall built to change the flow of a river and protect the river bank from scour.

HEADWALL: a wall at the end of a culvert to hold the soil fill above the culvert pipe.

HONEYCOMBING: badly made concrete with lots of holes, see page [1] - 54.

IMPACT: to hit hard, as when a vehicle hits a bridge parapet.

INVERT: the bottom of a channel, usually paved.

KERB: the step between the road and footpath, see page [1] – 7.

LAMINATIONS: thin layers, like pages of a book.

LANDSLIDE: a lot of soil and rocks slipping down a mountain or hill.

LUBRICATION SYSTEM: a system to supply oil or grease to a mechanical bridge bearing.

MAINTAIN (as in WELL MAINTAINED): to look after carefully and repair when it is necessary.

MARSDEN MATTING: a type of steel decking with holes, see page [2] - 22.

MASONRY: bricks or stones set together with mortar.

MASS CONCRETE: concrete without any steel in it.

MOISTURE: some water or dampness.

OVERBRIDGE: a bridge over a road.

OVERLOADED: carrying too much weight.

PANEL: a flat frame or plate.

PARAPET: a wall or rail along the edge of a bridge, see page [1] - 6.

PIER: a support between abutments for bridges with more than one span, see page [1] - 9.

PILE: a long, thin, foundation driven deep into the ground, see page [1]-13.

PILED: WALLS: walls made of long pieces of material driven into the ground.

PLATE (STEEL PLATE): a flat, stiff piece of steel.

POINTING: the mortar between bricks or stones in masonry.

PRESTRESSED (as in PRESTRESSED CONCRETE): a way of making concrete stronger with steel bars.

PTFE: a slippery white material used in bearings.

REINFORCEMENT: steel bars in reinforced concrete, to make it stronger.

RENDERING: a thin layer of mortar put on masonry or brickwork to protect it.

RENO MATTRESS: a long thin gabion.

RETAINING WALL: a wall to hold back soil, see page [1]-17.

RIP-RAP: a layer of loose rocks to protect a river bed from scour, see page [2] - 104.

RIVER TRAINING WORKS: constructions to stop the river changing its path, see page [2] - 39.

SAFETY PINS: the small clips on a Bailey bridge, that stop the panel pins from falling out.

SCOUR: holes in the river bed or bank caused by the flow of the river.

SEATING: the place where one part rests on another part. For example the place where a bearing is set on a pier or abutment.

SERVICES: cables and pipes belonging to other authorities.

SETTLEMENT: small movement downwards of a structure.

SHEET PILED WALL: a wall made from steel panels or timber boards hammered into the ground.

SLAB (CONCRETE SLAB): a large piece of concrete (for example a bridge deck).

SPACER PLATES: plates which are put between two other parts.

SPALL: to break off in a piece.

SPALLING: an area where concrete has broken away.

SPAN: the part of a bridge, or the distance, between the supports.

SPANDREL (SPANDREL WALLS): the side walls of a masonry arch bridge, see page [1] - 12.

SPREAD FOUNDATIONS: wide base to a pier or abutment, usually made of reinforced concrete.

STIFFENER: piece of steel used to strengthen a steel plate or girder and make it stronger against bending, see page [2] - 47.

STONE PITCHING: stones set in cement mortar to cover a sloping bank or an invert.

STRINGER: a horizontal deck member, see page [1] - 10.

STRUCTURAL (STRUCTURAL MEMBER): an important part of a bridge, for example a girder.

SUBSTRUCTURE: all the parts of a bridge, except for the superstructure, i.e. abutments, piers, etc.

SUPERSTRUCTURE: all of the deck, including parapets, trusses, beams and running surface.

SUSPENDED SPAN: the middle span of a cantilever bridge, see page [1] - 25.

TENSION (STRONG IN TENSION): pulling apart, see page [1] - 44.

TRUSS: a type of girder made from many small beams, see page [1] - 10.

TRUSS BRIDGE: a bridge which has truss spans, see page [1] - 10

UPSTREAM: the direction where the water in the river is coming from.

VIBRATION: repeated small movements caused by a heavy vehicle or perhaps an earthquake.

WATER BAR: a seal to stop water, see page [1] - 24.

WEB: the part of a girder that joins the flanges, see page [2] - 47.

WEEP HOLE: a hole to allow water to come through, see page [1] - 17.

WING WALLS: walls which are at the side of the abutment and part of it, see page [1] - 17.

APPENDIX B

EQUIPMENT LIST

This is a basic list of equipment. Each inspector should add other things that he finds are helpful.

All bridges

- This handbook.
- Waterproof clipboard for inspection reports.
- Waterproof pencil, pen or paint for marking concrete or steel.
- Flash light (torch).
- Straight edge (at least 2 m long).
- String line.
- Measuring Tapes (30 m and 3 or 5 m long).
- Bush knife or similar tool, to clear vegetation.
- Small shovel or trowel.
- Wire brush.
- Small paintbrush and paint, for repainting areas damaged during the inspection.
- Hammer (350-450gm).
- Set of spanners.
- Ranging rod or other long pole.
- Crack measuring gauge.

Timber bridges only

- Square spike.
- Hand drill and 5 mm diameter drill bits.
- 5 mm wooden plugs.
- Saw, for cutting off wooden plugs.
- Squirt can of creosote or other wood preservative.

Access and safety equipment

- A first aid box.
- Traffic warning signs and road cones.
- High visibility waistcoat.
- Safety helmet.
- Safety harness.
- Lifefloat.
- About 20 m of light rope.

A ladder will be needed occasionally, and for some inspections a boat will be required.

APPENDIX C

SAFETY DURING INSPECTIONS

Bridge inspections can be dangerous if the inspector is not careful. These notes will help the inspector to plan his work with safety in mind.

TRAFFIC

During the inspection you will be walking on the bridge and its road approaches looking at details of the bridge. You might not notice oncoming traffic.

Carry with you signs such as SURVEY IN PROGRESS, or DANGER or ROADWORKS, or similar signs which will warn drivers to expect people on the road. Always use the signs except on very lightly trafficked roads with clear visibility. Wear a bright coloured 'warning' jacket.

To properly inspect some bridges, such as through trusses, you must climb up above the traffic. Never do this without making sure that vehicles cannot come near you.

Protect the work area with cones, have assistants control the traffic or close the road for a short time, if necessary.

DANGEROUS PLACES

Many small bridges over shallow water can be inspected safely by a person on his own.

To properly inspect other bridges you must go into dangerous places, such as high up or near deep water. If you are going to inspect a bridge like this, take someone along (perhaps a driver) to make sure you are safe.

Remember two important things:

1. Always carry a rope and safety harness with you. Use them if you have to go into a dangerous place.
2. Do not go into dangerous places without an assistant.

Do not miss out parts of an inspection because it is difficult to get close to a place you should look at carefully. If necessary, move to another bridge and come back to the difficult bridge on another day with an assistant to carry out the inspection that you could not do alone.

Keep a look out for animals and insects which may harm you. Bridges provide lots of places where bees and wasps can build nests. Snakes and crocodiles may be found in sheltered parts under bridges. Be very careful looking at bearing shelves, especially just after a flood.

If you have to go into enclosed spaces, such as box girders, make sure that the manhole covers have been off for a long time to let fresh air in before you go in. People have died going into enclosed spaces where the air is bad. Always have someone standing outside, so that you can call to him for help.

CHEMICALS

Some of the chemicals used in timber treatment can be dangerous. If you make any holes during the inspection of a timber bridge, these should be filled with timber preservative. Chemicals such as Pentachlorophenol (P.C.P.) or coal-tar epoxy creosote can be used, but they are harmful to people, animals and fish.

When using timber preservatives remember:

- take care not to get the chemical onto your skin, use gloves;
- wash off any accidental splashes of chemical at once;
- do not smoke: some of the chemicals catch fire easily;
- try not to spill chemicals into the water: they will kill the fish;
- do not leave the chemicals where children or animals can touch them. Many children die every year because chemicals are left around;
- do not let any chemicals, liquids, gases or dust get into your nose or mouth or eyes. If it does by accident, wash it out as quickly as you can. If anyone drinks a chemical by mistake, take him to a doctor at once. Do not wait to see if he gets ill first.

APPENDIX D

EXAMPLE OF A COMPLETED REPORT FORM

The following example of a completed report form is for a bridge with:

one steel pier;

concrete abutments;

a composite steel and concrete deck.

The abutment pages are included twice; once for each abutment. The superstructure pages are also repeated because there are two spans. All of the report form pages are shown here, including pages not needed for the inspection of the bridge detailed above. This is because the report form is also a detailed index for references to part [2] of this book.

BRIDGE INSPECTION REPORT FORM

Bridge Number N3/125.3 Name CLEANWATER CREEK

Crossing CLEANWATER CREEK

Kilometre 31.7 on the MALAN to GOROKAN road

Instructions from the engineer to the inspector:

Check the river training works upstream. As you will see from the last report there have been problems before, and last year's flood was worse than most.

View of bridge looking from above.

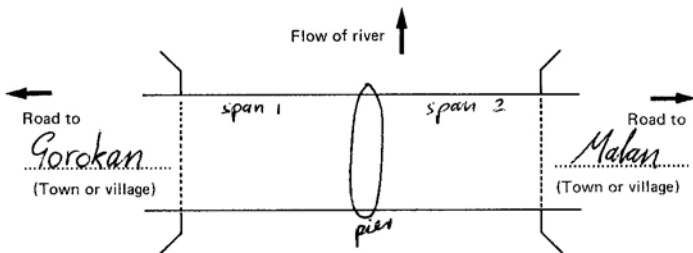

Notes from the inspector to the engineer:

The gabions forming the river training works require repairing before the next rains to prevent the abutment being undermined.

Inspected by JAMES BERA Date 5/1/88

Number of pages in report (Including sketches, notes, photos, etc.) 20

Report accepted by [Signature] Date 6-1-88

CONSTRUCTION DETAILS (from the Inventory)

		Correct ?	
		Yes	No
Span.....	14.0 m, 14.0 m	✓	
Running surface.....	Concrete	✓	
Deck.....	Composite steel concrete	✓	
Pier(s).....	Steel	✓	
Abutments.....	Concrete bank seat	✓	
Foundation type.....	Piled	✓	
Movement.....	Fixed at abutments, free at pier	✓	

Services	Details of service on bridge card	Service still there ?		Service damaged ?	
		Yes	No	Yes	No
Telephone	Cable in 3" diameter duct.	✓			✓
Electricity					
Gas					
Watermain					
Sewer drain					
Oil pipeline					

Notes.....

Signs	Sign still there ?		Sign damaged ?		Notes
	Yes	No	Yes	No	
Details of signs on bridge card					
(2X) 50kph speed limit	✓		✓		one each end.

Previous inspection

By..... JAMES BERA Date 2/11/86
 Comments..... Each flood pushes the river bed towards the Malan side and damages the bank protection gabions.

Handbook page (2)	DECK AND PARAPETS	Problem	How bad ?		How much ?			Note or sketch reference
		No Yes	Not very bad Bad	Very serious	Not much Some	A lot		
	POSSIBLE PROBLEM							

24 TIMBER SURFACE

Dirt or plants between boards ?								
Decay ?								
Insect attack ?								
Splitting of timbers ?								
Loose or damaged fixings ?								

25 TIMBER RUNNING STRIPS

Damage to running strips ?								
Loose or damaged fixings ?								

26 RAILWAY OR TRAM RAILS

Loose rail fixings ?								
----------------------	--	--	--	--	--	--	--	--

26 KERBS

Damaged or loose kerbs ?	<input checked="" type="checkbox"/>							
--------------------------	-------------------------------------	--	--	--	--	--	--	--

26 FOOTPATHS

Damaged footpaths ?	<input checked="" type="checkbox"/>								
All checked								Yes <input checked="" type="checkbox"/>	No <input type="checkbox"/>

27

PARAPETS, RAILINGS AND GUARD RAILS

Impact damage ?	<input checked="" type="checkbox"/>							
Loose or damaged fixings ?	<input checked="" type="checkbox"/>							
Loose post base ?	<input checked="" type="checkbox"/>							

28 STEEL OR ALUMINIUM PARAPETS

Damaged galvanising or paint ?		<input checked="" type="checkbox"/>	<input checked="" type="checkbox"/>		<input checked="" type="checkbox"/>				
Corrosion ?		<input checked="" type="checkbox"/>	<input checked="" type="checkbox"/>		<input checked="" type="checkbox"/>				
All checked								Yes <input checked="" type="checkbox"/>	No <input type="checkbox"/>

Paint coming off base plates

Rust starting on base plates.

Handbook page (21)	PARAPETS AND JOINTS	Problem		How bad ?			How much ?		Note or sketch reference
		No	Yes	Not very bad	Bad	Very serious	Not much	Some	
	POSSIBLE PROBLEM								

29 CONCRETE PARAPETS

Cracking ?									
Spalling ?									
Corrosion of reinforcement ?									
Poor concrete ?									

30 TIMBER PARAPETS

Decay ?									
Insect attack ?									
Splitting of timbers ?									

31 MASONRY PARAPETS

Cracking ?									
Movement or bending of parapet ?									
Poor pointing ?									
Deterioration of the bricks or stonework ?									

All checked Yes No

32 EXPANSION JOINT AT *Malan* ABUTMENT OR PIER No..... (from above)

Damage to concrete of deck end or ballast wall near joint ?	✓								
Debris or vegetation in joint ?	✓								
Loose or damaged fixings ?	✓								
Damage or corrosion to metal parts ?	✓								
Damage to rubber waterbars ?	✓								

All checked Yes No

Handbook page (2)	THE RIVER	Problem		How bad ?			How much ?			Note or sketch reference
		No	Yes	Not very bad	Bad	Very serious	Not much	Some	A lot	
	POSSIBLE PROBLEM									

THE RIVER

34 BLOCKAGES IN WATERWAY

Debris against piers or abutments ?	✓									
Remains of old bridges under or upstream of the bridge ?	✓									
Fencing or buildings under bridge ?	✓									
Trees or bushes growing under bridge ?		✓	✓					✓		Some young trees need clearing

37 CHANGE OF RIVER PATH

River changing path upstream from bridge ?		✓			✓			✓		see note 1 on separate sheet
New islands forming upstream of bridge ?	✓									

39 RIVER TRAINING WORKS

River attack beyond the upstream end of the river training works ?	✓									
Damage to sheet piled walls ?										
Loss of rip-rap ?										
Damage to gabions, timber, fencing etc. ?		✓			✓			✓		See note 1
Damage to trees ?	✓									

All checked Yes No

Handbook page (2)	SUPERSTRUCTURE SPAN No. <i>Malan</i>	Problem		How bad ?			How much ?			Note or sketch reference
		No	Yes	Not very bad	Bad	Very serious	Not much	Some	A lot	
	POSSIBLE PROBLEM									

41

SUPERSTRUCTURE

42 GENERAL

(from below the deck –
above and below for a through truss)

Impact damage to beams, girders, trusses or bracings ?	<input checked="" type="checkbox"/>									
Debris or vegetation on beams, girders, trusses or bracings or in joints ?	<input checked="" type="checkbox"/>									
Water coming through the deck ?	<input checked="" type="checkbox"/>									
Water from the deck drainage flowing onto girders, trusses, beams or bracings ?	<input checked="" type="checkbox"/>									
Not enough headroom for overbridge ?	<input checked="" type="checkbox"/>									If the road has been resurfaced MIN HEADROOM =

All checked Yes No

44

MAIN BEAMS, GIRDERS, TRUSSES
AND BRACINGS

44 CONCRETE BEAMS

Cracking ?										
Spalling ?										
Corrosion of reinforcement ?										
Poor concrete ?										

47 STEEL GIRDERS AND BRACINGS

Deterioration of paint or galvanising ?		<input checked="" type="checkbox"/>	<input checked="" type="checkbox"/>			<input checked="" type="checkbox"/>				<i>Paint im from Malan abutment on down river side is broken, allowing rusting of web.</i>
Corrosion ?		<input checked="" type="checkbox"/>	<input checked="" type="checkbox"/>			<input checked="" type="checkbox"/>				
Bends in webs, flanges, stiffeners or bracings ?	<input checked="" type="checkbox"/>									
Loose bolts or rivets ?	<input checked="" type="checkbox"/>									
Cracking ?	<input checked="" type="checkbox"/>									

All checked Yes No

Handbook page (2)	SUPERSTRUCTURE SPAN No. <i>Gorokan</i>	Problem		How bad ?			How much ?		Note or sketch reference
		No	Yes	Not very bad	Bad	Very serious	Not much	Some	
	POSSIBLE PROBLEM								

41

SUPERSTRUCTURE

42 GENERAL

(from below the deck —
above and below for a through truss)

Impact damage to beams, girders, trusses or bracings ?	<input checked="" type="checkbox"/>								
Debris or vegetation on beams, girders, trusses or bracings or in joints ?	<input checked="" type="checkbox"/>								
Water coming through the deck ?	<input checked="" type="checkbox"/>								
Water from the deck drainage flowing onto girders, trusses, beams or bracings ?	<input checked="" type="checkbox"/>								
Not enough headroom for overbridge ?	<input checked="" type="checkbox"/>								If the road has been resurfaced MIN HEADROOM =

All checked Yes No

44

MAIN BEAMS, GIRDERS, TRUSSES
AND BRACINGS

44 CONCRETE BEAMS									
Cracking ?									
Spalling ?									
Corrosion of reinforcement ?									
Poor concrete ?									

47 STEEL GIRDERS AND BRACINGS

Deterioration of paint or galvanising ?	<input checked="" type="checkbox"/>								
Corrosion ?	<input checked="" type="checkbox"/>								
Bends in webs, flanges, stiffeners or bracings ?	<input checked="" type="checkbox"/>								
Loose bolts or rivets ?	<input checked="" type="checkbox"/>								
Cracking ?	<input checked="" type="checkbox"/>								

All checked Yes No

Handbook page (Z)	SUPERSTRUCTURE SPAN No.	Problem		How bad ?			How much ?		Note or sketch reference
		No	Yes	Not very bad	Bad	Very serious	Not much	Some	
	POSSIBLE PROBLEM								

50 STEEL TRUSSES

Deterioration of paint or galvanising ?									
Corrosion ?									
Bends in truss members ?									
Bent or damaged joints ?									
Bent or damaged bracings ?									
Loose bolts or rivets ?									
Cracking of steel members ?									

53 TIMBER BEAMS

Decay ?									
Insect attack ?									
Splitting of timber ?									
Separation of laminations on glue laminated beams ?									
Loose or corroded nails, spikes or fixing wires ?									

56 TIMBER TRUSSES

Decay ?											
Insect attack ?											
Splitting of timber ?											
Loose deck to truss connection ?											
Loose or corroded bolts or pins at joints ?											
Bends in truss timbers ?											
Damaged or corroded steel parts ?											
All checked									Yes	No	

Handbook page (2)	SUPERSTRUCTURE SPAN No. <i>Malan</i>	Problem		How bad ?			How much ?			Note or sketch reference
		No	Yes	Not very bad	Bad	Very serious	Not much	Some	A lot	
	POSSIBLE PROBLEM									

59

UNDERSIDE OF DECK

59 CONCRETE

Cracking ?	<input checked="" type="checkbox"/>								
Spalling ?	<input checked="" type="checkbox"/>								
Corrosion of reinforcement ?	<input checked="" type="checkbox"/>								
Poor concrete ?	<input checked="" type="checkbox"/>								
Not enough cover to reinforcement ?	<input checked="" type="checkbox"/>								

60 STEEL

Deterioration of paint or galvanising ?									
Corrosion ?									
Bends in stringers or plates ?									
Loose bolts or rivets ?									
Cracking ?									

61 TIMBER

Decay ?									
Insect attack ?									
Split timbers ?									
Loose or corroded bolts or pins ?									

63 MASONRY JACK ARCH DECKS

Change of shape of arch ?									
Cracking or spalling ?									
Poor pointing ?									

All checked

Yes

No

Handbook page (2)	SUPERSTRUCTURE SPAN No. <i>Gorokan</i>	Problem		How bad ?			How much ?		Note or sketch reference
		No	Yes	Not very bad	Bad	Very serious	Not much	Some	
	POSSIBLE PROBLEM								

59

UNDERSIDE OF DECK

59 CONCRETE

Cracking ?		✓		✓				✓	<i>See note 2 below.</i>
Spalling ?	✓								
Corrosion of reinforcement ?	✓								
Poor concrete ?	✓								
Not enough cover to reinforcement ?	✓								

60 STEEL

Deterioration of paint or galvanising ?									
Corrosion ?									
Bends in stringers or plates ?									
Loose bolts or rivets ?									
Cracking ?									

61 TIMBER

Decay ?									
Insect attack ?									
Split timbers ?									
Loose or corroded bolts or pins ?									

63 MASONRY JACK ARCH DECKS

Change of shape of arch ?									
Cracking or spalling ?									
Poor pointing ?									

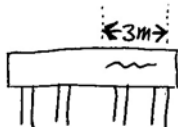
All checked Yes No 

Note 2 Crack in cross beam
(0.5mm wide) looking from Gorokan
abutment.

Handbook page (2)	BEARINGS ABUTMENT NAME <i>Matan</i> PIER No. POSSIBLE PROBLEM	Problem		How bad ?			How much ?			Note or sketch reference
		No	Yes	Not very bad	Bad	Very serious	Not much	Some	A lot	

64

BEARINGS

64 ALL BEARINGS

Debris or vegetation around bearings ?	<input checked="" type="checkbox"/>									
Bad drainage to bearing shelf ?	<input checked="" type="checkbox"/>									
Not enough room for the bridge span to move ?	<input checked="" type="checkbox"/>									
Bearing not seated properly ?	<input checked="" type="checkbox"/>									
Bridge span not seated properly on bearing ?	<input checked="" type="checkbox"/>									
Damaged bedding mortar ?	<input checked="" type="checkbox"/>									

66 RUBBER BEARINGS

Splitting, tearing or cracking of rubber ?	<input checked="" type="checkbox"/>									
Damaged or loose bolts or pins at fixed bearings ?	<input checked="" type="checkbox"/>									

67 METAL BEARINGS

Parts not properly seated ?										
Parts not free to move ?										
Problem with the lubrication system ?										
Sliding surfaces damaged ?										
Cracks or bends in metal Parts ?										
Corrosion of metal parts ?										

69 EARTHQUAKE RESTRAINTS

Damaged or loose earthquake restraints ?										
--	--	--	--	--	--	--	--	--	--	--

All checked Yes No

Handbook page (Z)	BEARINGS ABUTMENT NAME <i>Gorokan</i> PIER No. POSSIBLE PROBLEM	Problem		How bad ?			How much ?		Note or sketch reference
		No	Yes	Not very bad	Bad	Very serious	Not much	Some	

64

BEARINGS

64 ALL BEARINGS

Debris or vegetation around bearings ?	<input checked="" type="checkbox"/>									
Bad drainage to bearing shelf ?	<input checked="" type="checkbox"/>									
Not enough room for the bridge span to move ?	<input checked="" type="checkbox"/>									
Bearing not seated properly ?	<input checked="" type="checkbox"/>									
Bridge span not seated properly on bearing ?	<input checked="" type="checkbox"/>									
Damaged bedding mortar ?	<input checked="" type="checkbox"/>									

66 RUBBER BEARINGS

Splitting, tearing or cracking of rubber ?	<input checked="" type="checkbox"/>									
Damaged or loose bolts or pins at fixed bearings ?	<input checked="" type="checkbox"/>									

67 METAL BEARINGS

Parts not properly seated ?										
Parts not free to move ?										
Problem with the lubrication system ?										
Sliding surfaces damaged ?										
Cracks or bends in metal Parts ?										
Corrosion of metal parts ?										

69 EARTHQUAKE RESTRAINTS

Damaged or loose earthquake restraints ?											
All checked										Yes <input checked="" type="checkbox"/>	No <input type="checkbox"/>

Handbook page (2)	BAILEY BRIDGES SPAN No.	Problem	How bad ?			How much ?			Note or sketch reference
		No	Yes	Not very bad	Bad	Very serious	Not much	Some	
POSSIBLE PROBLEM									

75

BAILEY BRIDGES

Missing safety pins ?												
Missing panel pins ?												
Missing or loose bolts ?												
Missing rakers or tie plates ?												
Missing or loose sway braces ?												
Missing, loose or damaged horizontal bracing frames ?												
Missing or loose transom clamps ?												
Wear at stringer to transom seating ?												
Cracking ?												
Bends in members ?												
Deterioration of paint or galvanising ?												
Corrosion ?												
Settlement of bearings ?												
Damage to bearings or base plates ?												
Maximum vertical sag ?	Upstream side					Downstream side						
Maximum horizontal bend ?	Upstream side					Downstream side						
All checked										Yes	No	

Handbook page (2)	ABUTMENT, WING WALLS AND RETAINING WALLS ABUTMENT NAME <i>Malan</i> POSSIBLE PROBLEM	Problem		How bad ?			How much ?			Note or sketch reference
		No	Yes	Not very bad	Bad	Very serious	Not much	Some	A lot	

82 ABUTMENT, WING WALLS AND RETAINING WALLS

82 GENERAL

Erosion or scour near abutment ?		✓			✓			✓	See note 1
Damage to caissons or piles ?	✓								
Movement of abutment ?	✓								
Debris against abutment ?	✓								
Vegetation growing on or in abutment ?	✓								
Scour near to retaining walls ?									
Movement of retaining walls ?									
Water leaking down through the expansion joint ?	✓								

87 DRAINAGE SYSTEM

Not enough weepholes ?	✓								
Weepholes not working ?		✓	✓			✓			Only downriver weepholes working.
Water leaking through the abutment ?	✓								

89 CONCRETE ABUTMENTS, WING WALLS AND RETAINING WALLS

Cracking ?	✓								
Spalling ?	✓								
Corrosion of reinforcement ?	✓								
Poor concrete ?	✓								

All checked Yes No

Handbook page (2)	ABUTMENT, WING WALLS AND RETAINING WALLS	Problem		How bad ?			How much ?		Note or sketch reference	
	ABUTMENT NAME	No	Yes	Not very bad	Bad	Vary serious	Not much	Some		A lot
	<i>Gorokan</i>									
	POSSIBLE PROBLEM									

82 ABUTMENT, WING WALLS AND RETAINING WALLS

82 GENERAL

Erosion or scour near abutment ?	<input checked="" type="checkbox"/>									
Damage to caissons or piles ?	<input checked="" type="checkbox"/>									
Movement of abutment ?	<input checked="" type="checkbox"/>									
Debris against abutment ?	<input checked="" type="checkbox"/>									
Vegetation growing on or in abutment ?	<input checked="" type="checkbox"/>									
Scour near to retaining walls ?										
Movement of retaining walls ?										
Water leaking down through the expansion joint ?	<input checked="" type="checkbox"/>									

87 DRAINAGE SYSTEM

Not enough weepholes ?	<input checked="" type="checkbox"/>									
Weepholes not working ?	<input checked="" type="checkbox"/>									
Water leaking through the abutment ?	<input checked="" type="checkbox"/>									

89 CONCRETE ABUTMENTS, WING WALLS AND RETAINING WALLS

Cracking ?	<input checked="" type="checkbox"/>									
Spalling ?	<input checked="" type="checkbox"/>									
Corrosion of reinforcement ?	<input checked="" type="checkbox"/>									
Poor concrete ?	<input checked="" type="checkbox"/>									

All checked Yes No

Handbook page (2)	ABUTMENT, WING WALLS AND RETAINING WALLS ABUTMENT NAME POSSIBLE PROBLEM	Problem		How bad ?			How much ?		Note or sketch reference	
		No	Yes	Not very bad	Bad	Very serious	Not much	Some		A lot
91 MASONRY ABUTMENTS AND RETAINING WALLS										
	Cracking ?									
	Bulging ?									
	Poor pointing ?									
	Deterioration of bricks or stones ?									
93 GABION ABUTMENTS AND RETAINING WALLS										
	Settlement or bulging of gabions ?									
	Damage to gabion wires or ties ?									
94 TIMBER ABUTMENTS AND RETAINING WALLS										
	Decay ?									
	Insect attack ?									
	Splitting of timber ?									
	Loose or corroded binding cables ?									
	Loose or corroded fixing spikes ?									
All checked								Yes	No	

Handbook page (2)	EMBANKMENTS ABUTMENT NAME <i>Sarakan</i> POSSIBLE PROBLEM	Problem		How bad ?			How much ?			Note or sketch reference
		No	Yes	Not very bad	Bad	Very serious	Not much	Some	A lot	

96

EMBANKMENTS AND FILL IN FRONT OF ABUTMENTS

96 GENERAL

Scour at base of slopes ?	<input checked="" type="checkbox"/>								
Slip of fill ?	<input checked="" type="checkbox"/>								
Erosion of fill ?	<input checked="" type="checkbox"/>								
Cracking of road or embankment edge ?	<input checked="" type="checkbox"/>								
Piping failures of fill ?	<input checked="" type="checkbox"/>								

99 PILED WALLS

Forward movement ?									
Deterioration of piles ?									

100 STONE PITCHING SLOPE PROTECTION

Cracking ?									
Poor pointing ?									
Scour or erosion at edge ?									
Pieces broken off ?									

102 GABION SLOPE PROTECTION

Too much movement of gabions ?	<input checked="" type="checkbox"/>								
Damage to gabion wires or ties ?	<input checked="" type="checkbox"/>								

104 RIP-RAP SLOPE PROTECTION

Rip-rap being washed away ?									
Bed settlement ?									

All checked

Yes

No

Handbook page (2)	PIERS	Problem		How bad ?			How much ?			Note or sketch reference
	PIER No.	No	Yes	Not very bad	Bad	Very serious	Not much	Some	A lot	
	POSSIBLE PROBLEM									

PIERS

110 GENERAL

Scour near base of pier ?		✓	✓			✓				200 mm deep hole at upriver end. see note 1.
Damage to caissons or piles ?	✓									
Movement of pier ?	✓									
Impact damage ?	✓									
Debris against pier ?	✓									
Vegetation growing on pier ?	✓									
Water leaking past expansion joint ?	✓									

113 CONCRETE PIERS

Cracking ?									
Spalling ?									
Corrosion of reinforcement ?									
Poor concrete ?									

114 MASONRY PIERS

Cracking ?									
Poor pointing ?									
Deterioration of masonry ?									

All checked Yes No

Handbook page (2)	PIERS PIER No.	Problem	How bad ?			How much ?			Note or sketch reference
		No Yes	Not very bad Bad Very serious	Not much Some A lot					
POSSIBLE PROBLEM									

116 STEEL PIERS

Debris in joints ?	<input checked="" type="checkbox"/>									
Deterioration of paint or galvanising ?	<input checked="" type="checkbox"/>									I could not get close enough to check properly.
Corrosion ?	<input checked="" type="checkbox"/>									
Bends in steel members or at joints ?	<input checked="" type="checkbox"/>									
Loose bolts or rivets ?	<input checked="" type="checkbox"/>									
Cracking ?	<input checked="" type="checkbox"/>									

117 TIMBER PIERS

Debris in joints ?											
Decay ?											
Insect attack ?											
Splitting of timber ?											
Loose bolts or pins at joints ?											
Bends in pier timbers ?											
Damaged or corroded steel parts ?											
All checked										Yes <input type="checkbox"/>	No <input checked="" type="checkbox"/>

Handbook page (2)	CULVERTS	Problem		How bad ?			How much ?		Note or sketch reference
		No	Yes	Not very bad	Bad	Very serious	Not much	Some	
	POSSIBLE PROBLEM								

119

CULVERTS

(also use page 1-5 of the bridge inspection forms as required)

119 GENERAL

Debris, vegetation etc. in or near culvert ?									
Settlement of parts of the culvert ?									
Scour at ends of culvert or at edge of apron ?									

121 CONCRETE CULVERT BARRELS

Cracking ?									
Spalling ?									
Corrosion of reinforcement ?									
Poor concrete ?									

122 CORRUGATED STEEL CULVERTS

Change of shape of culvert barrel ?									
Damage or deterioration to paint or galvanising ?									
Corrosion of steel ?									
Loose or corroded bolts ?									

123 CULVERT APRONS

Cracking and damage to concrete or stone pitching ?									
Damage to gabions ?									

124 HEADWALLS

Movement of headwall ?									
Concrete: cracking, spalling, corrosion of reinforcement or poor concrete ?									
Masonry: cracking, poor pointing or deterioration of bricks or stones ?									

All checked

Yes	No	
-----	----	--

CLEANWATER CREEK BRIDGE INSPECTION

NOTE 1

